

第3層遺構実測図 (1:200)

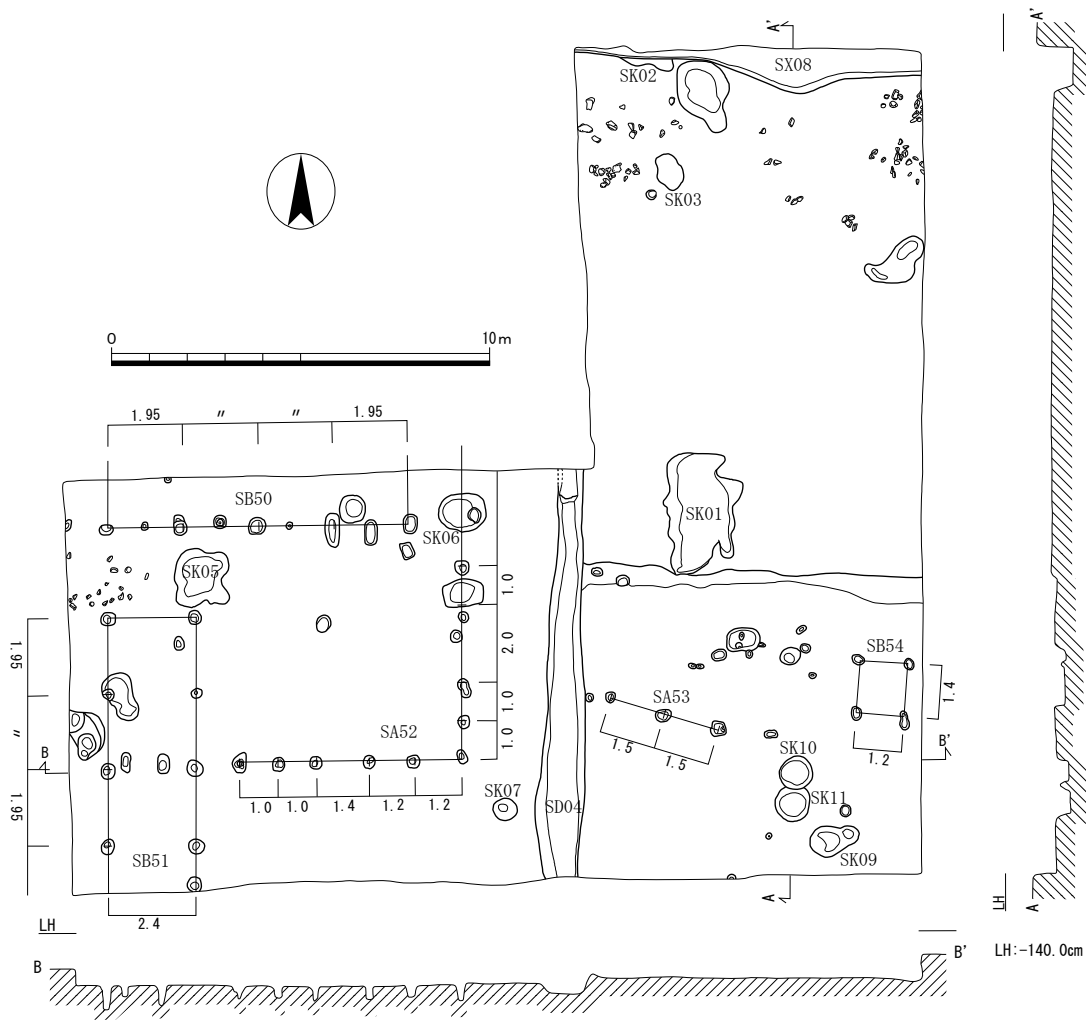

第2層遺構実測図 (1:200)

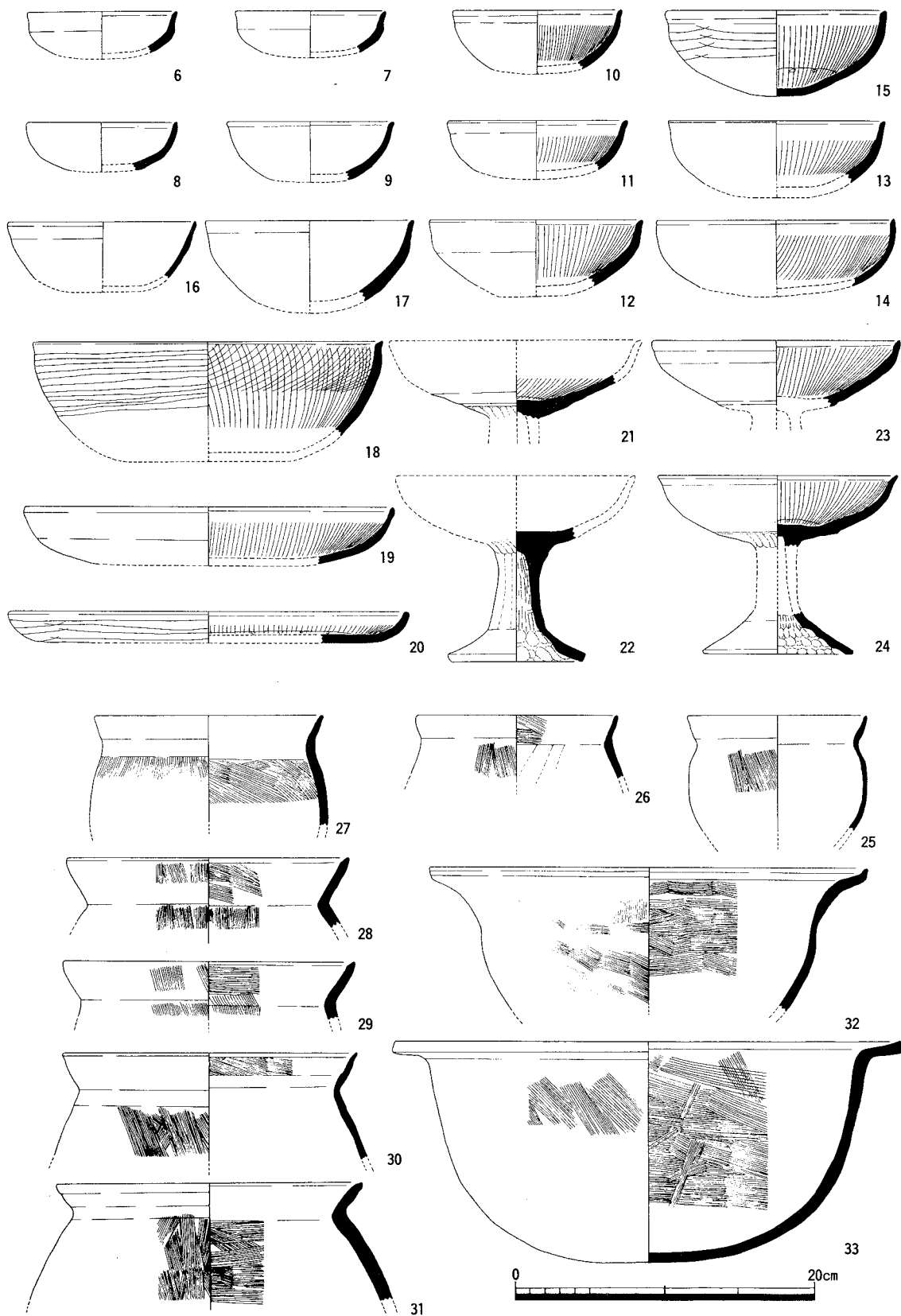



SD38 下層出土土師器 (1:4)

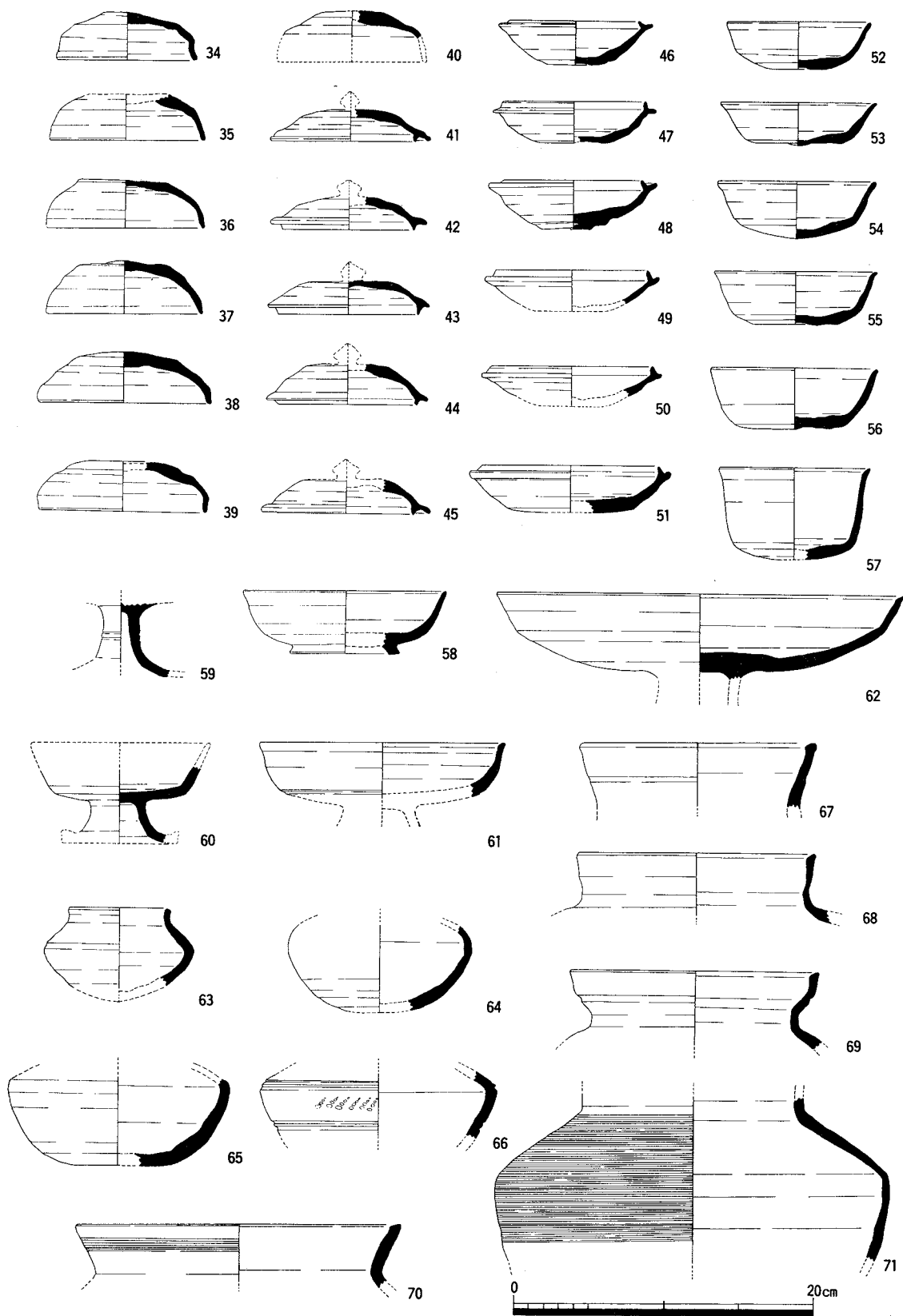

SD38 下層出土須惠器 (1:4)

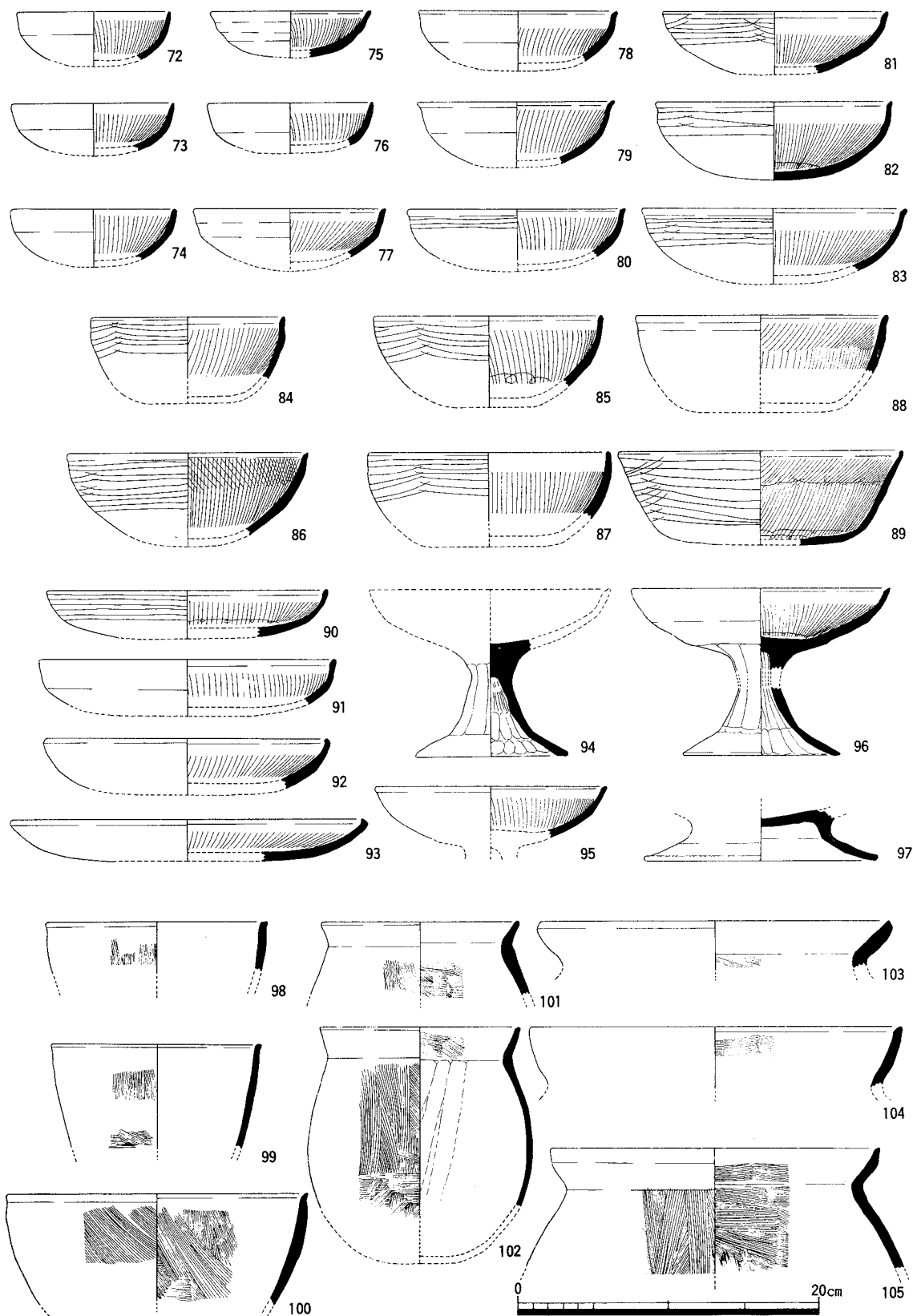

SD38 中層出土土師器 (1:4)

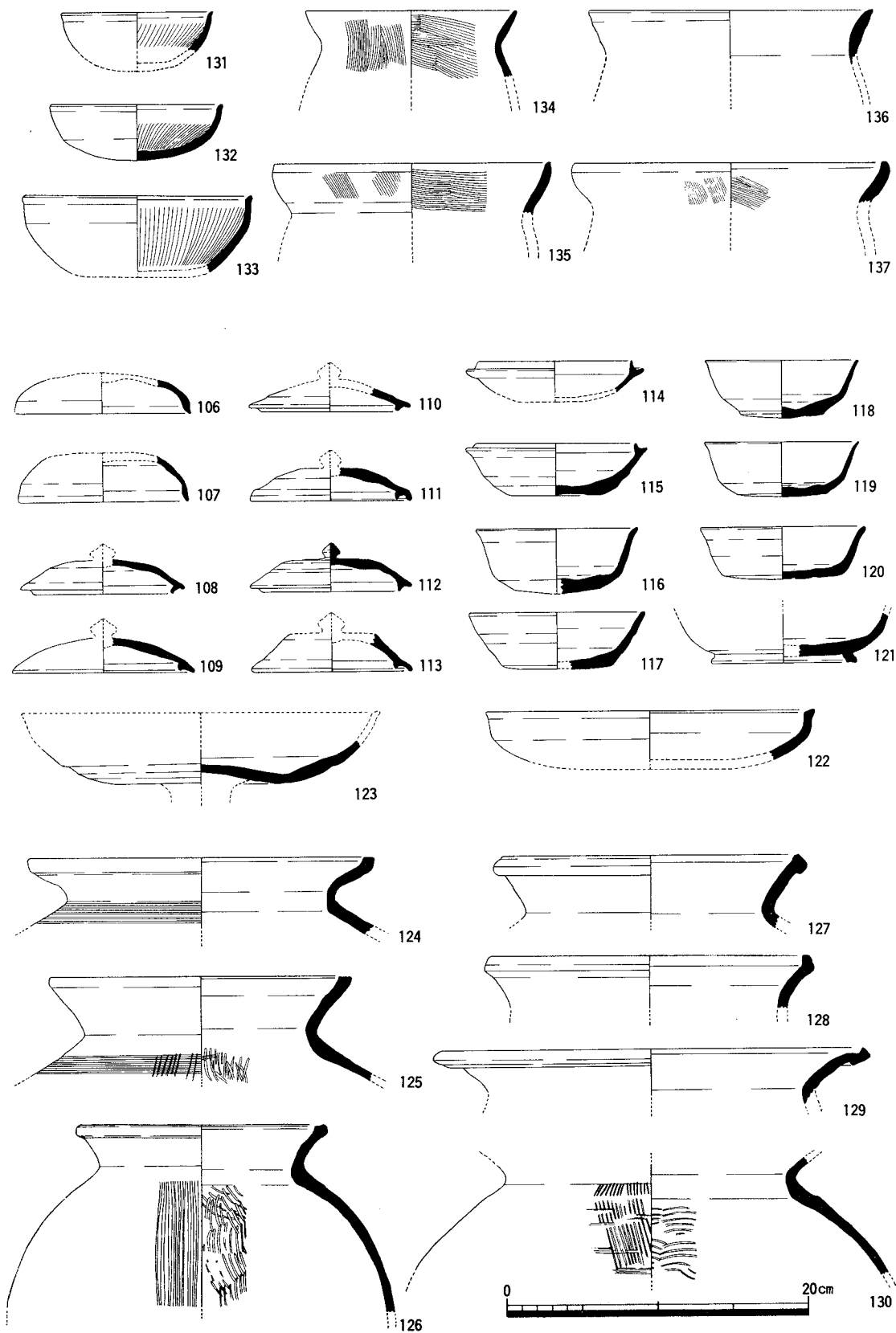

SD38 中層出土須恵器 106 ~ 130 SD38 上層出土土師器 131 ~ 137(1:4)

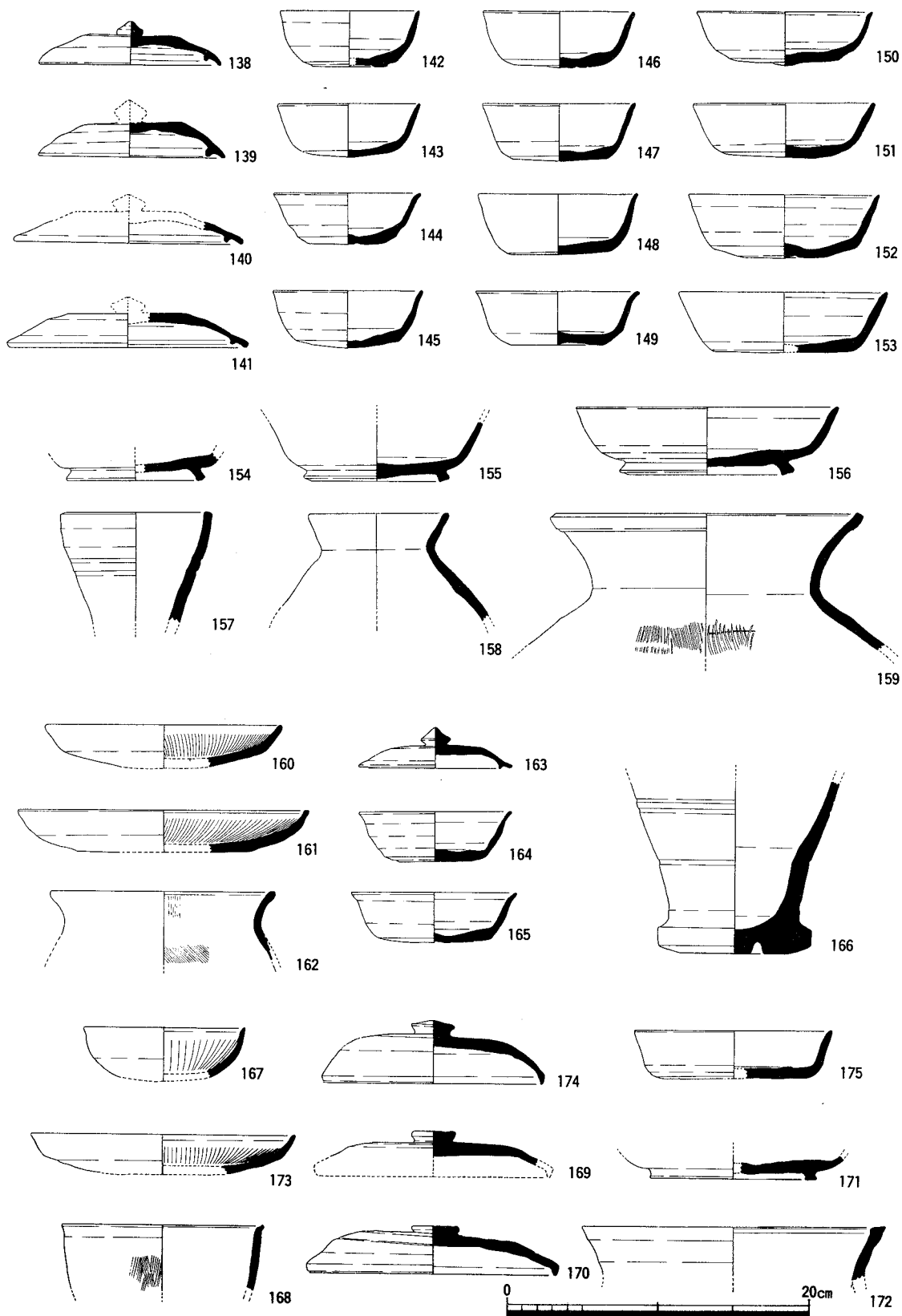

SD38 上層出土土器 須惠器 138 ~ 159、SD37 出土土器 土師器 160 ~ 162 須惠器 163 ~ 166、SK34 出土土器 土師器 167・168 須惠器 169 ~ 172、SK35 出土土器 土師器 173 須惠器 174・175(1:4)



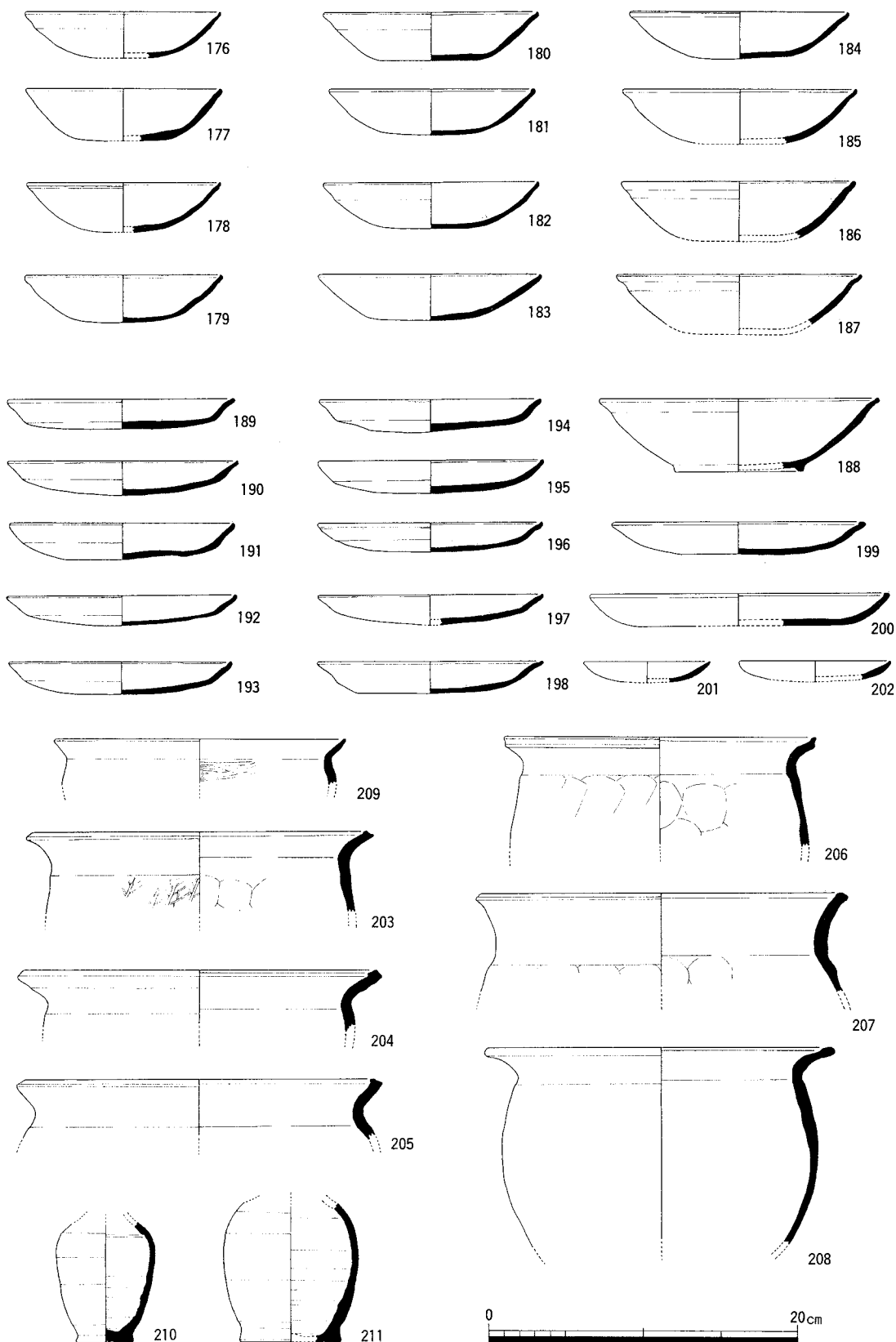

SK23 出土土器 土師器 176 ~ 208 黒色土器 209 須恵器 210・211(1:4)

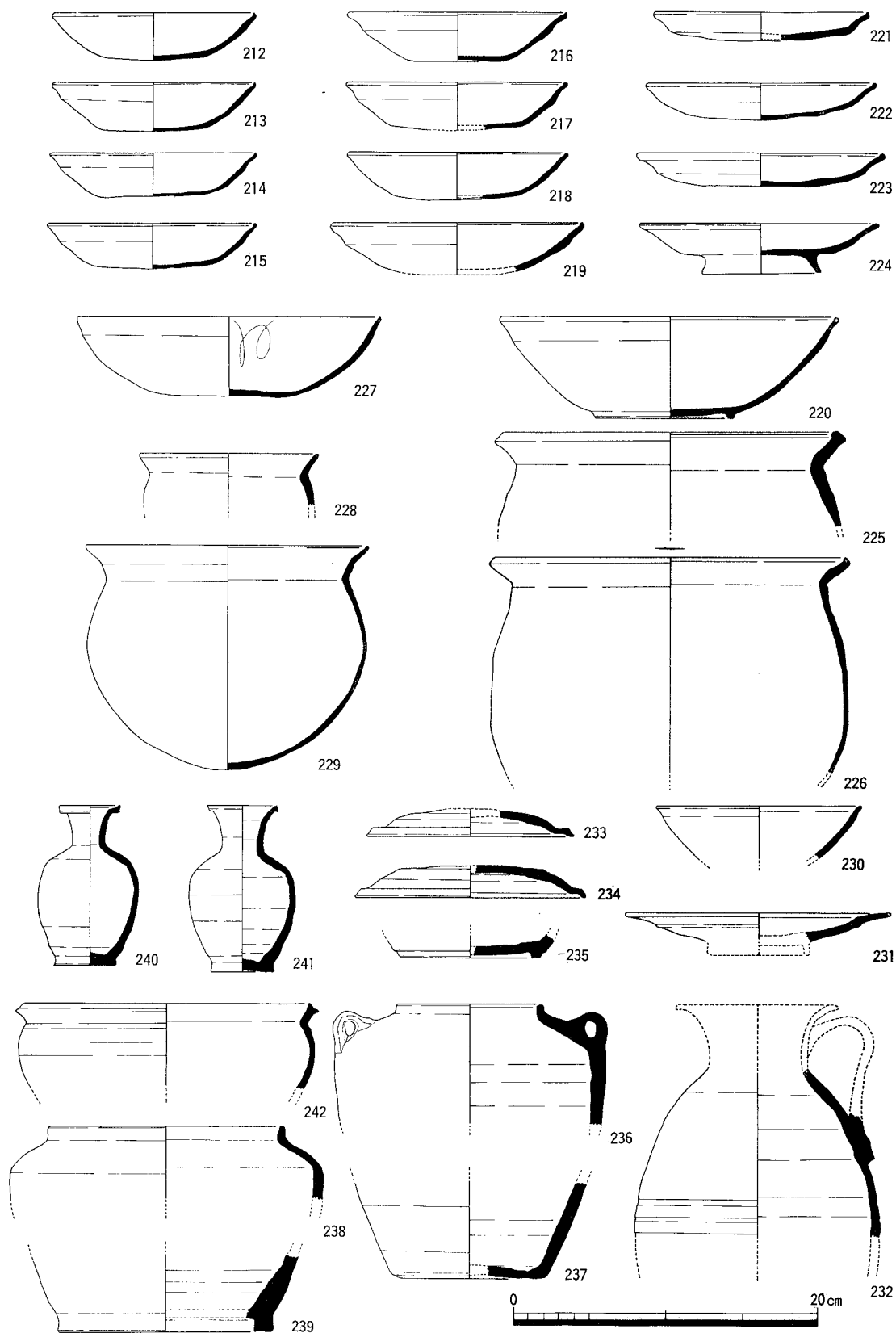

SK21 出土土器 土師器 212 ~ 226 黒色土器 227 ~ 229 緑釉陶器 230 灰釉陶器 231・232 須恵器 233 ~ 242(1:4)

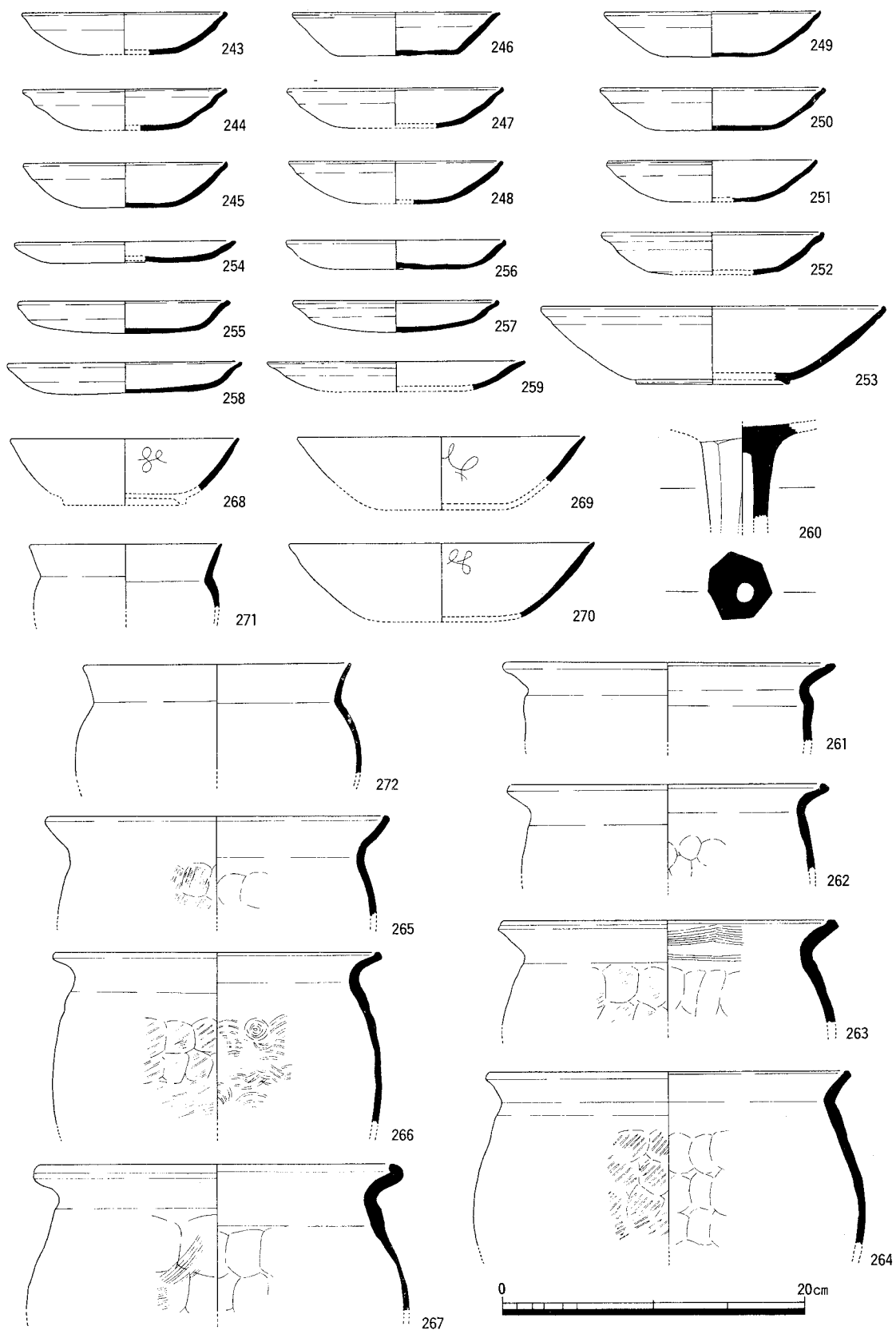

SK20 出土土器 土師器 243 ~ 267 黑色土器 263 ~ 272(1:4)

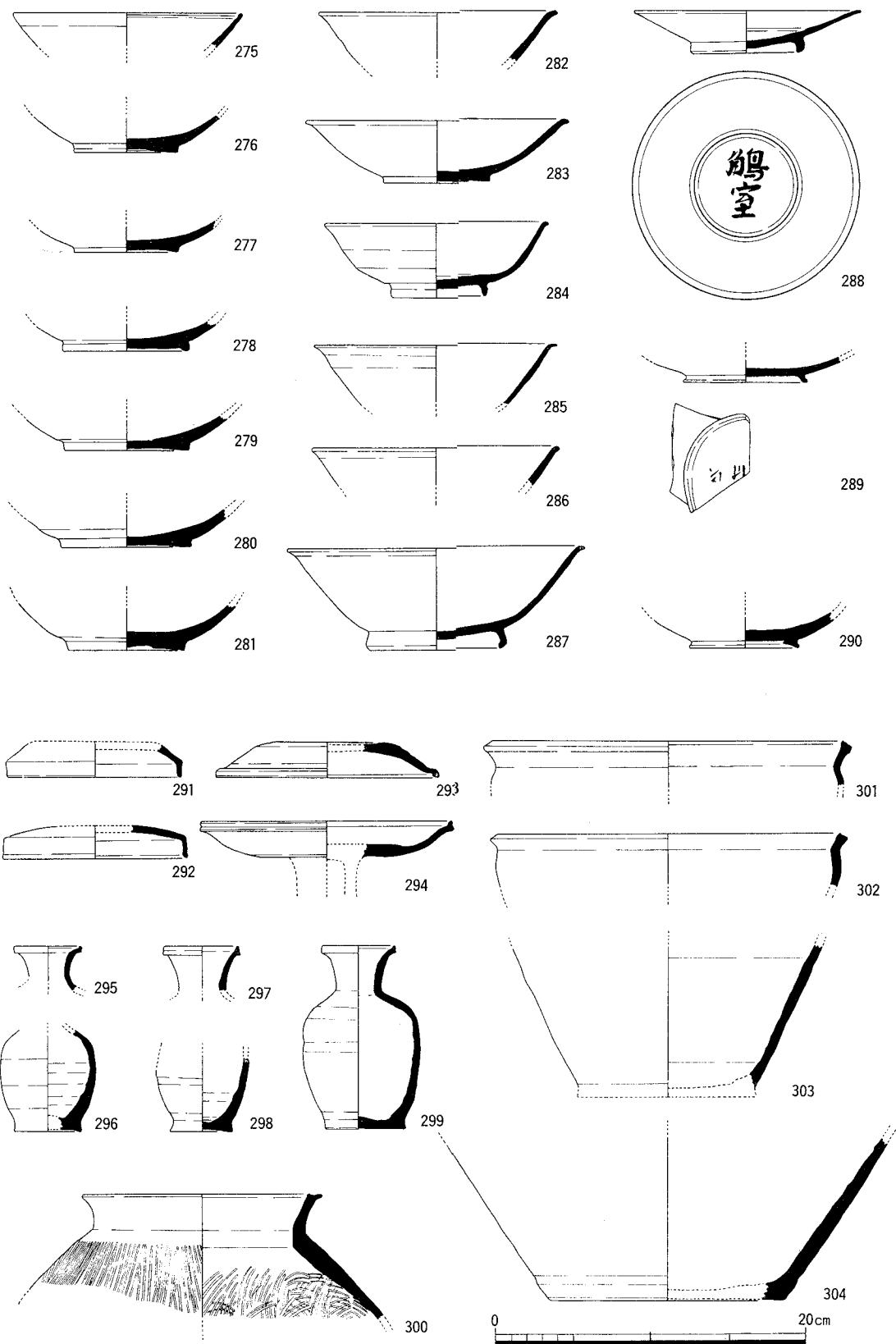

SK20 出土土器 緑釉陶器 275 ~ 283・292 灰釉陶器 284 ~ 290 須恵器 291 ~ 304(1:4)

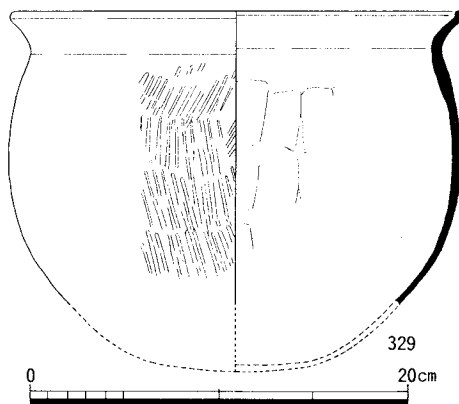
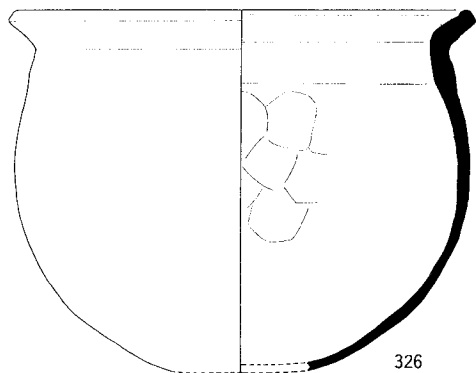
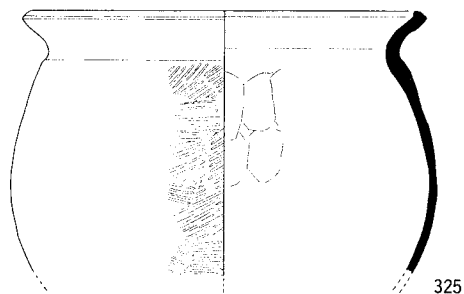
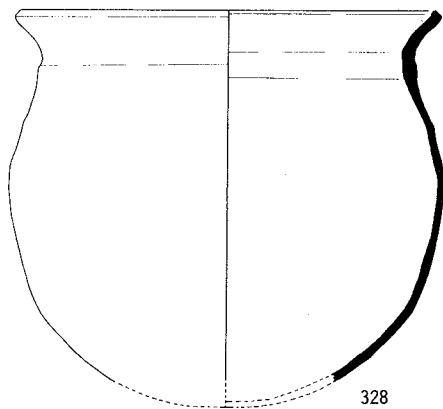
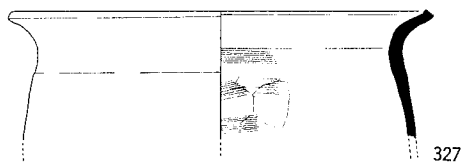
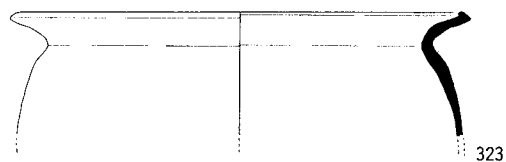
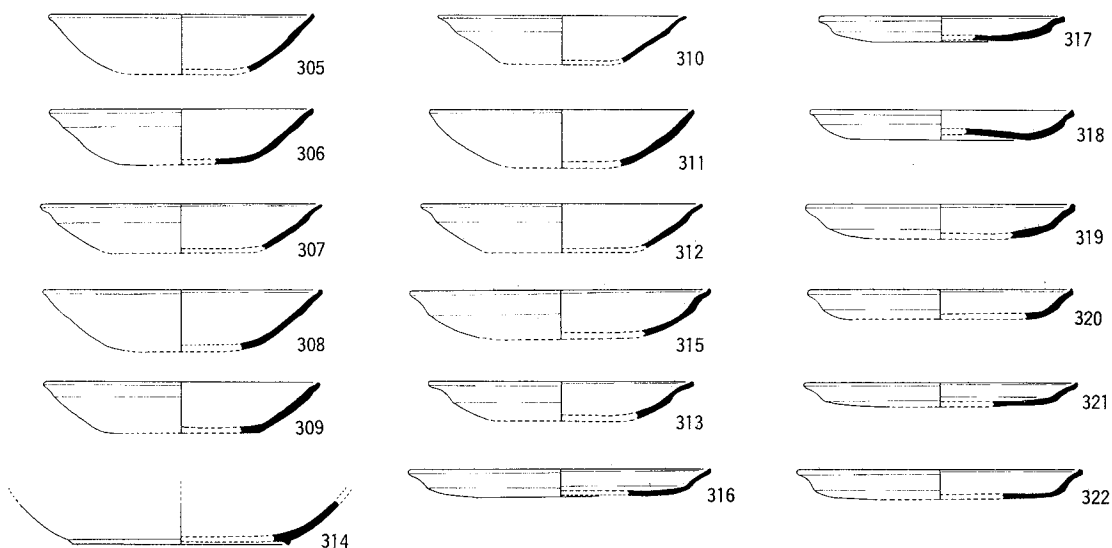

SD13 第 4 層出土土師器 (1:4)

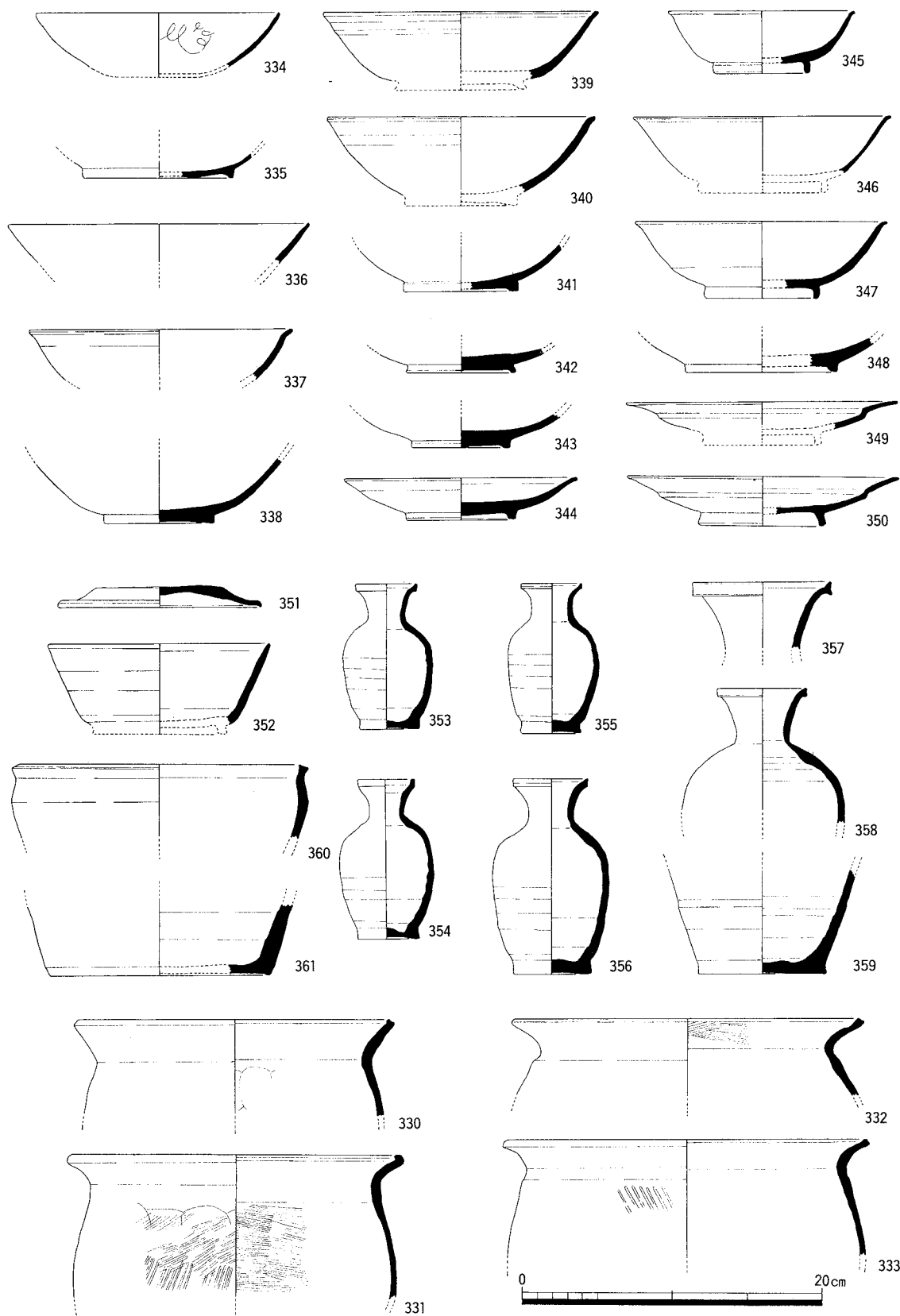

SD13 第 4 層出土土器 土師器 330 ~ 333 黑色土器 334 ~ 336 緑釉陶器 337 ~ 344 灰釉陶器 345 ~ 350 須恵器 351 ~ 361(1:4)

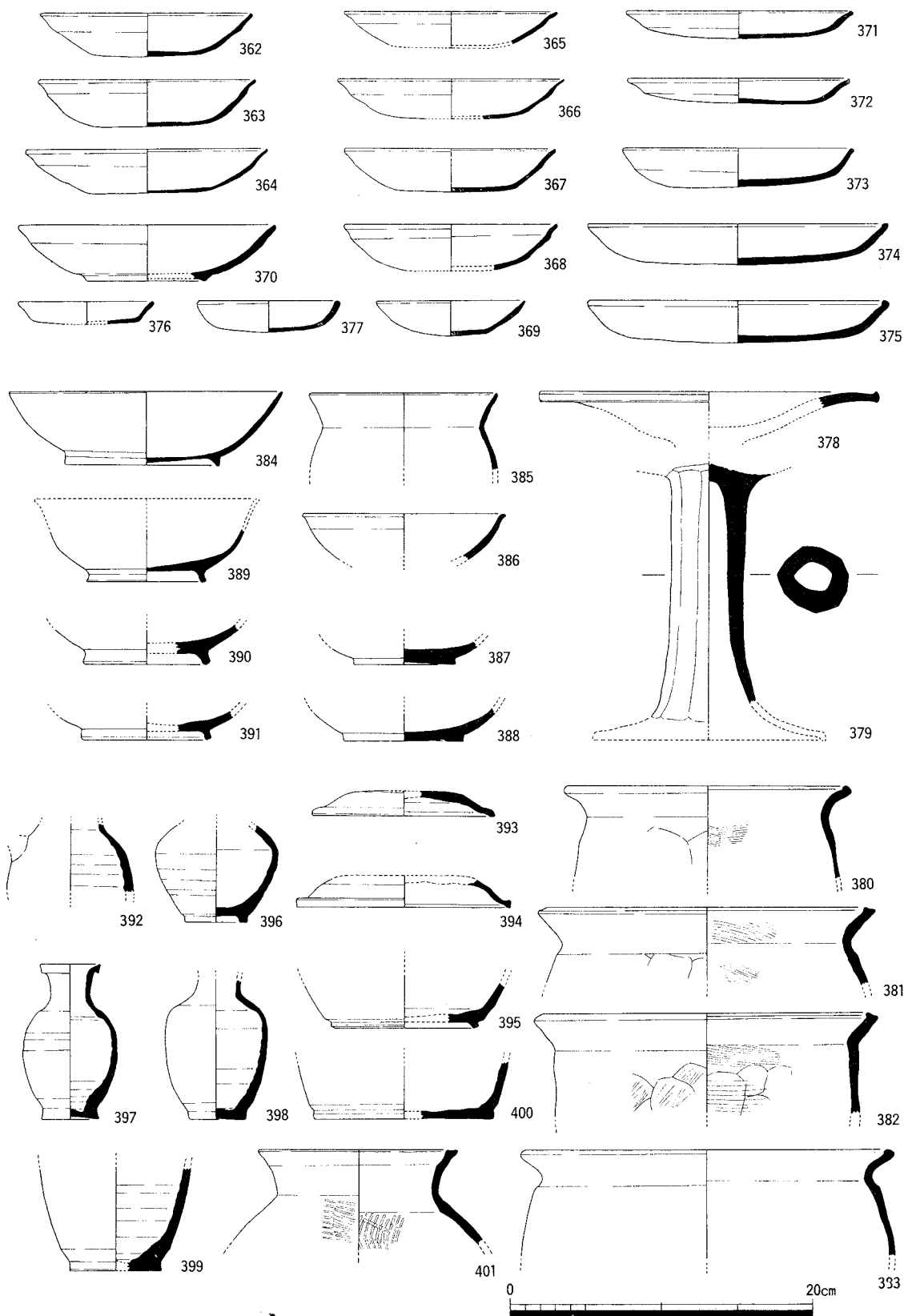

SD12 出土土器 土師器 362 ~ 383 黒色土器 384・385 緑釉陶器 386 ~ 388 灰釉陶器 389 ~ 392 須恵器 393 ~ 401(1:4)

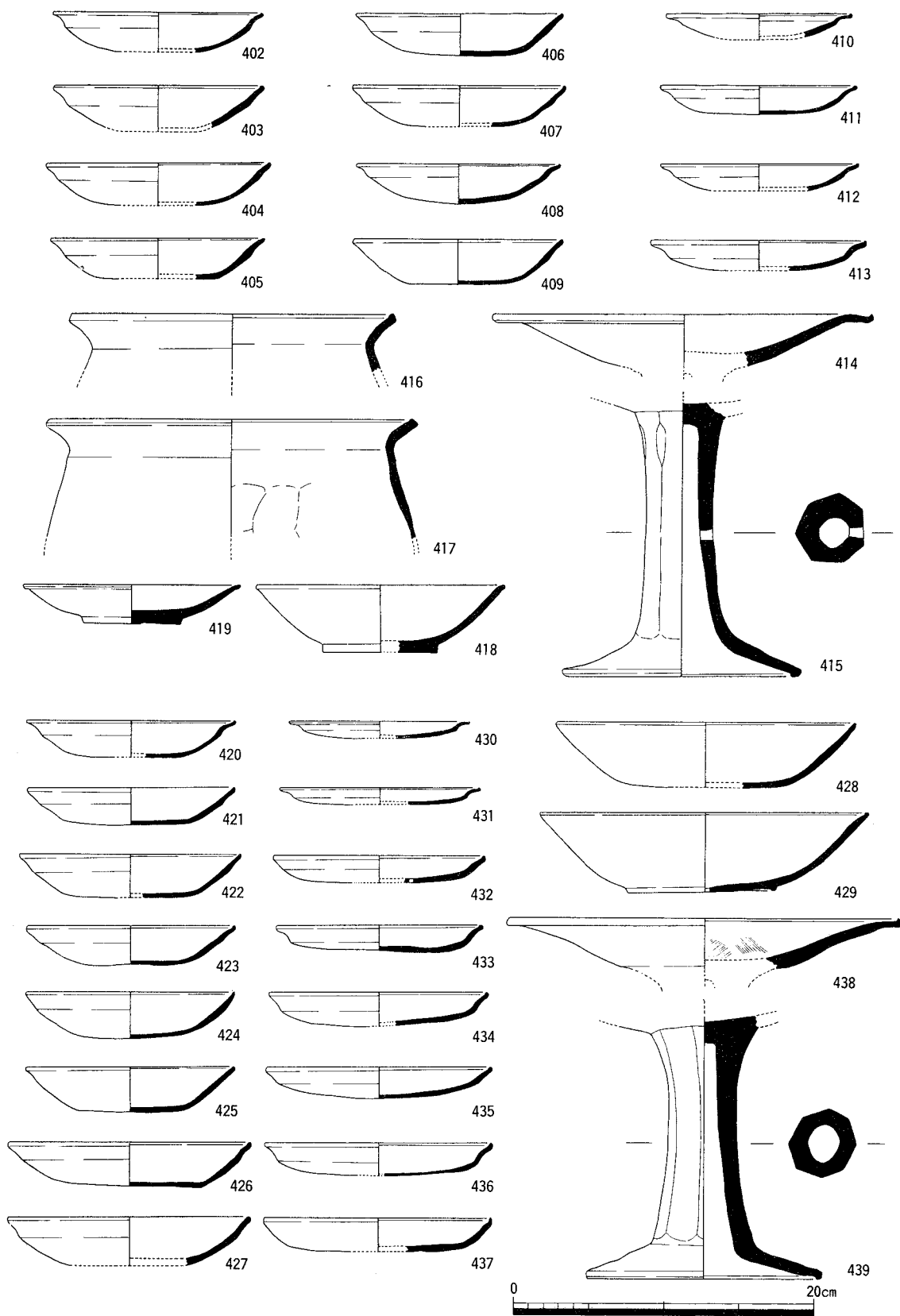

SK18 出土土器 土師器 402 ~ 417 緑釉陶器 418・419、SD14 出土土器 土師器 420 ~ 439(1:4)



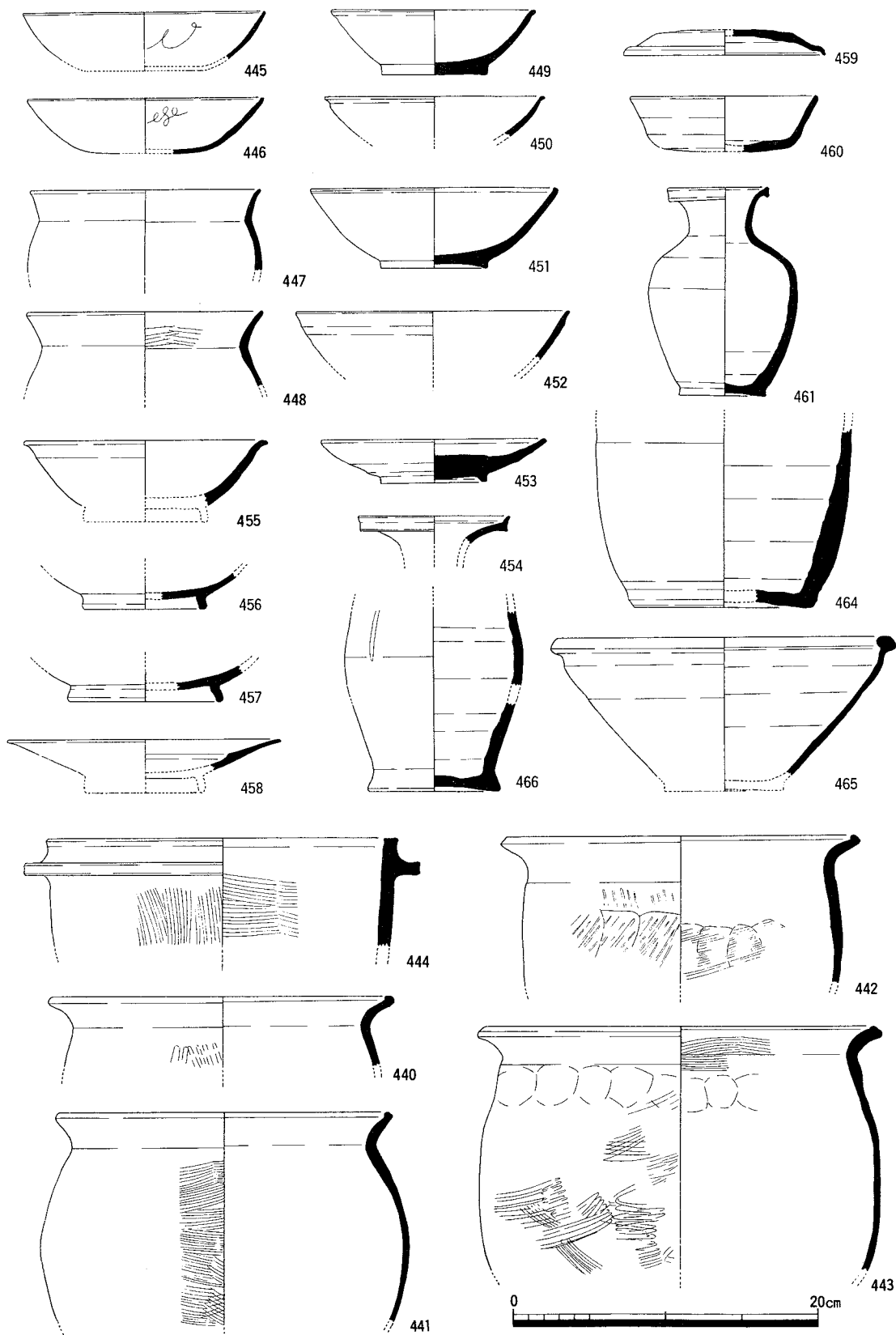

SD14 出土土器 土師器 440～444 黒色土器 445～448 緑釉陶器 449～454 灰釉陶器 455～458 須恵器 459～465 青磁 466(1:4)

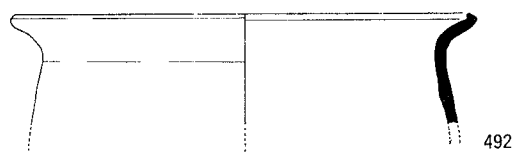
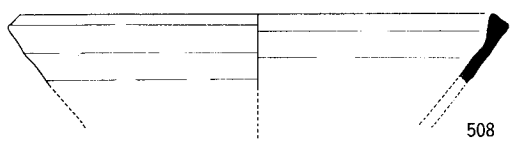
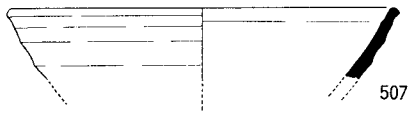
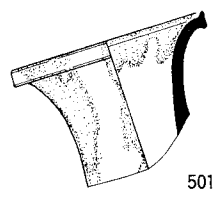
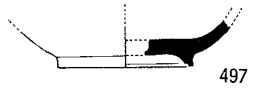
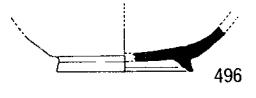
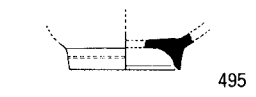
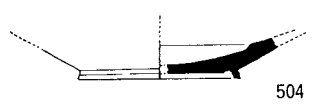
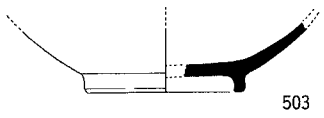
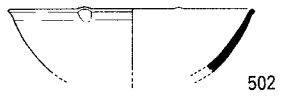
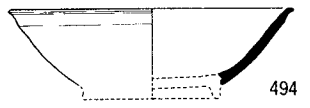
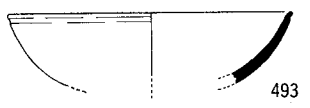
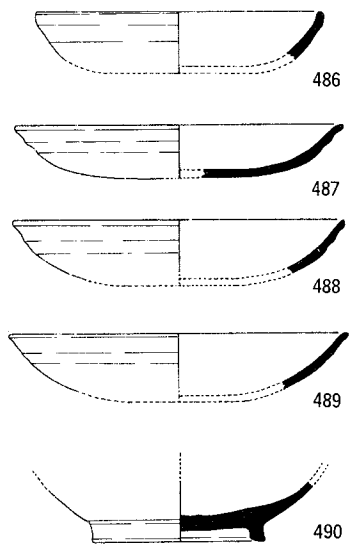
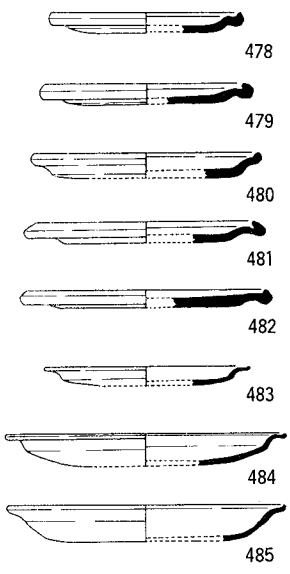
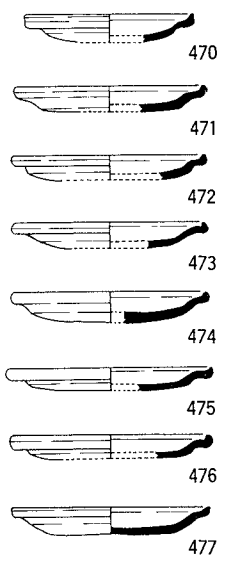

第2層出土土器 土師器 470～492 緑釉陶器 493～500 二彩陶器 501 灰釉陶器 502～504 白磁 505・506 須恵器 507・508(1:4)

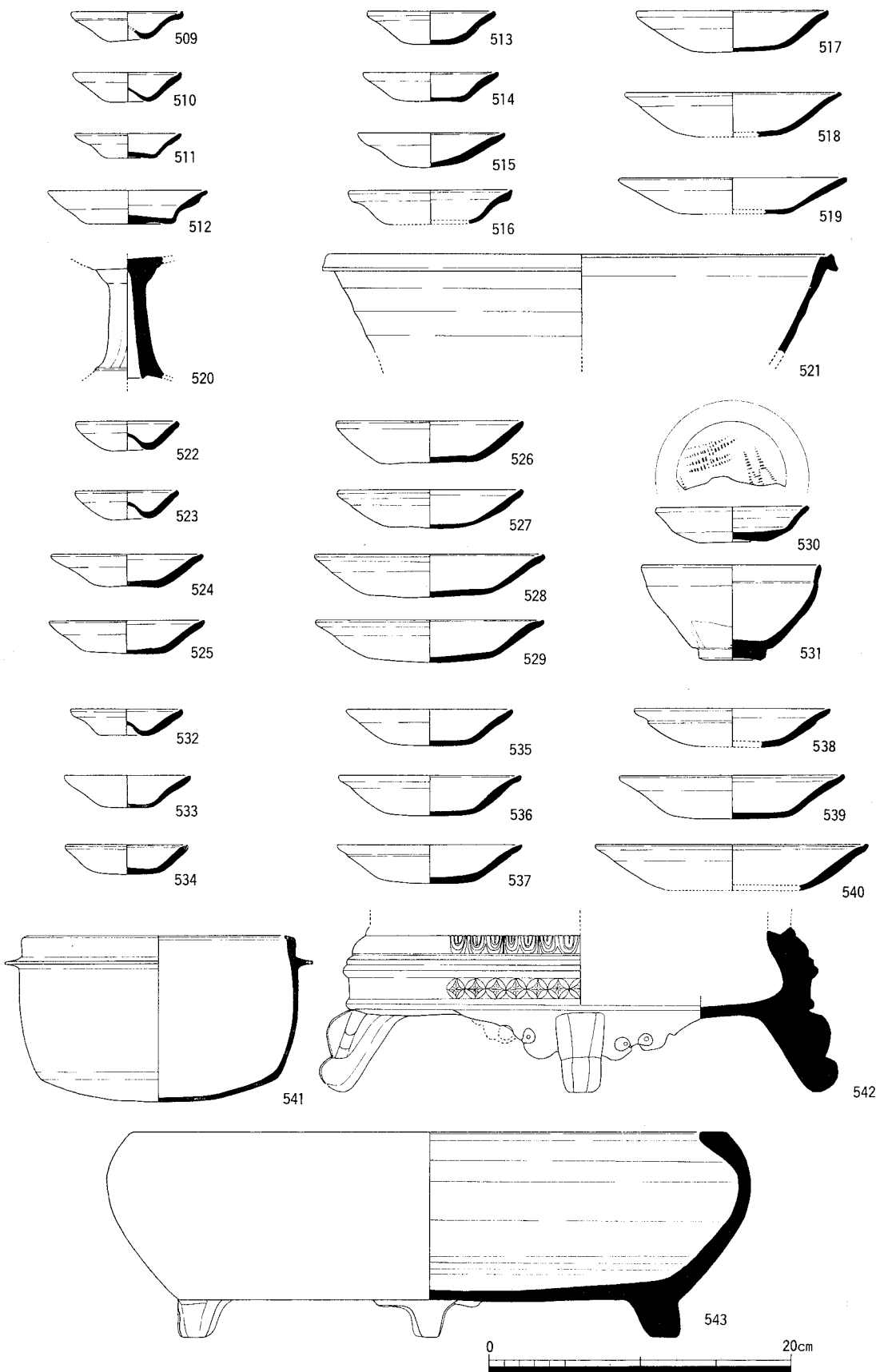

SK01 出土土器 土師器 509 ~ 520 瓦器 521、SD04 出土土器 土師器 522 ~ 529 青磁 530 陶器 531 SX08 出土土器 土師器 532 ~ 540 瓦器 541 ~ 543(1:4)

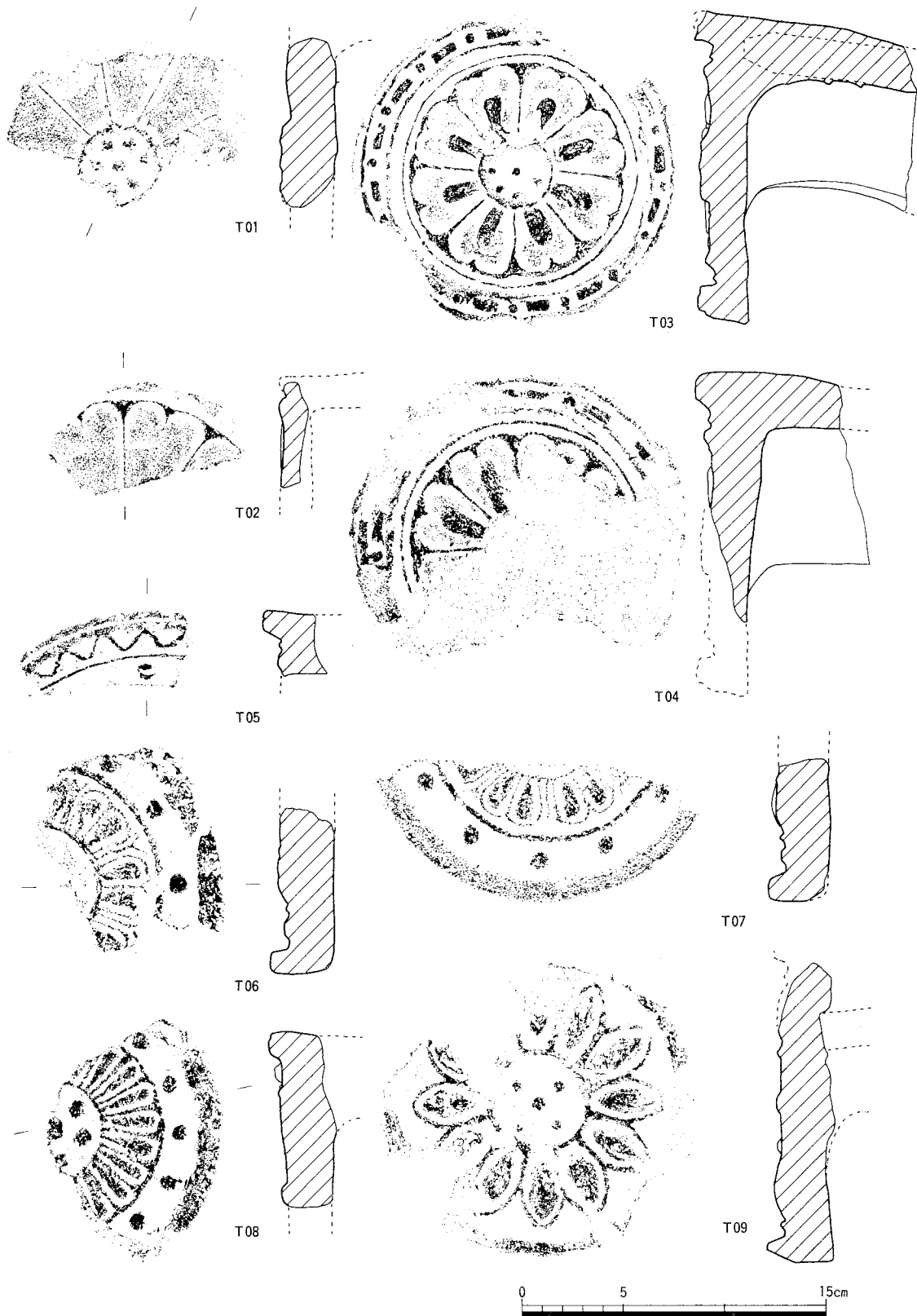

軒丸瓦 (1:3)

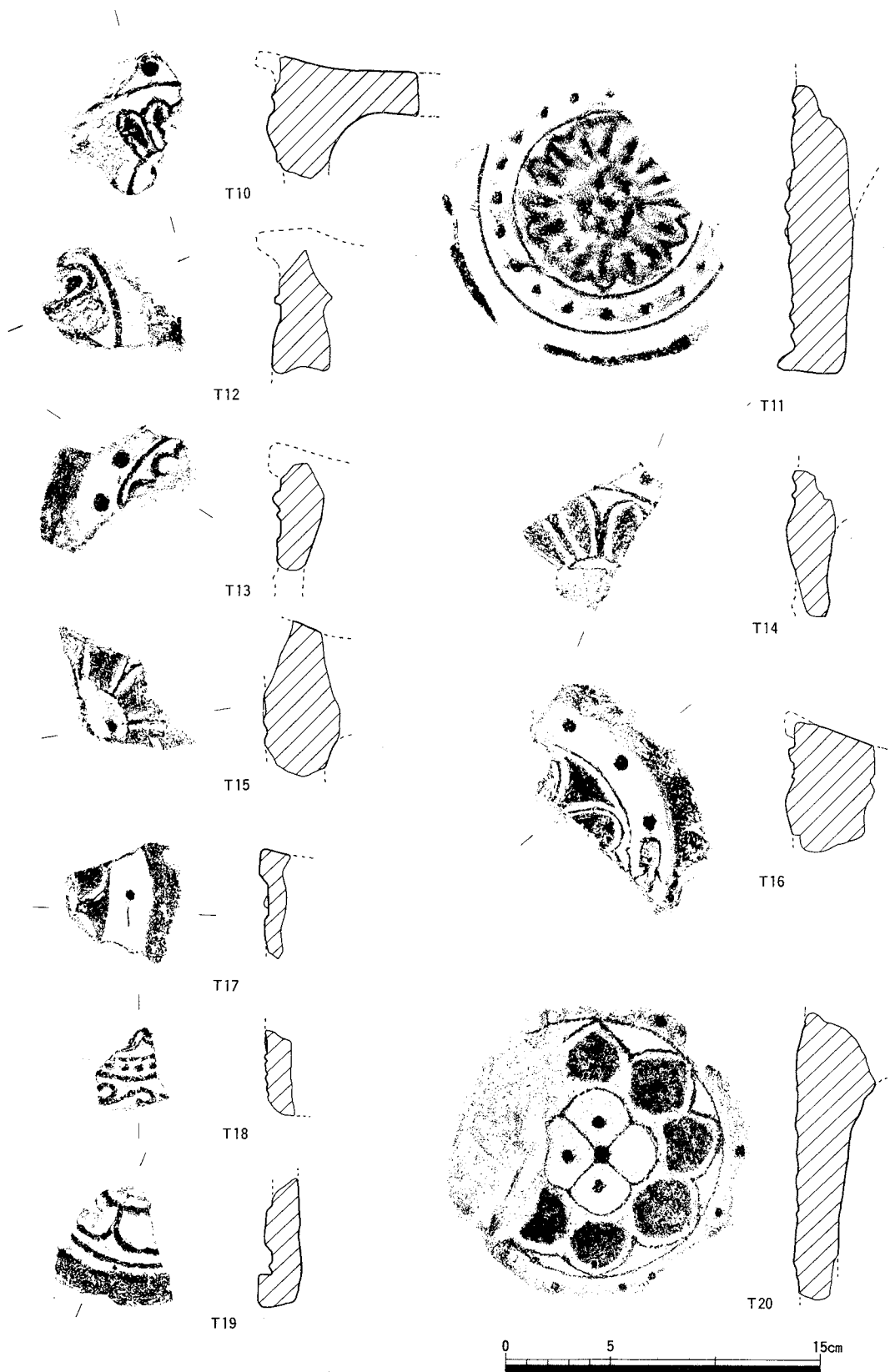

軒丸瓦 (1:3)

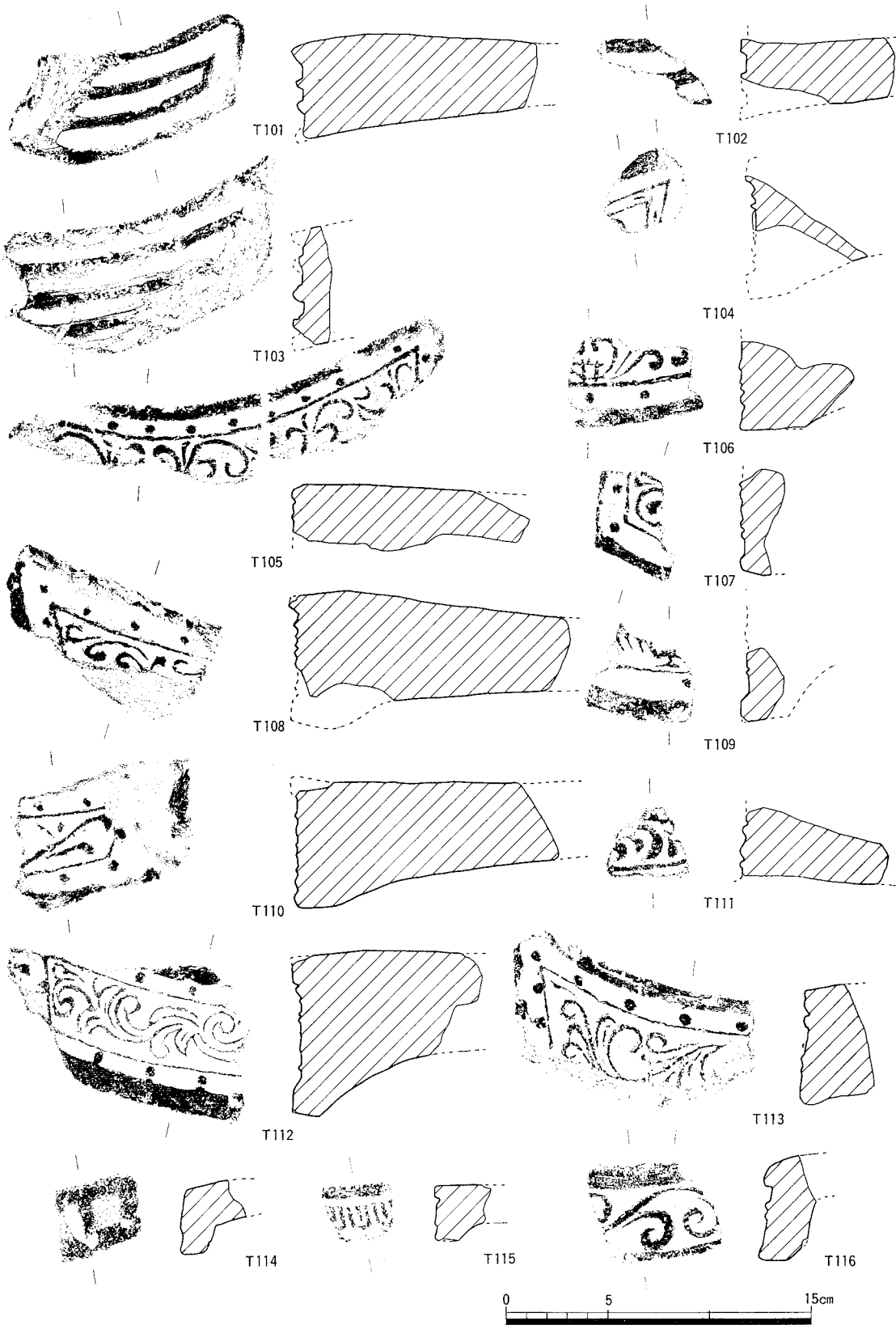

軒平瓦 (1:3)

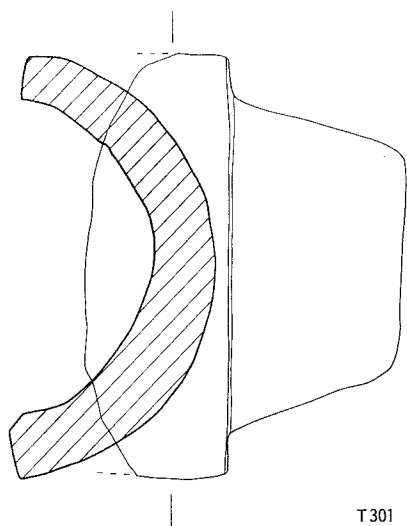

T301

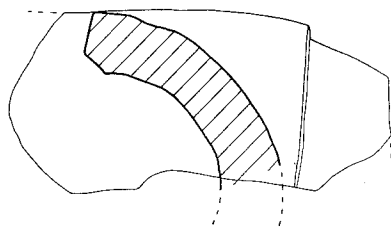

T302

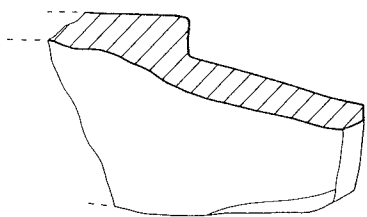

T303

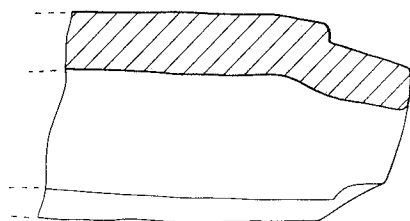

T304

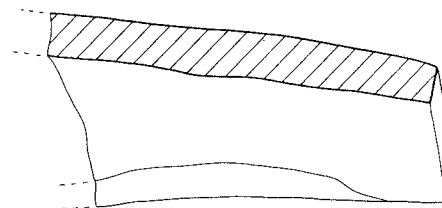
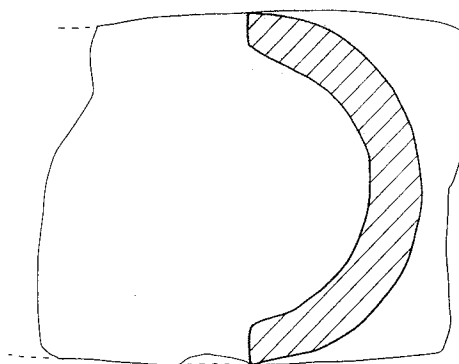
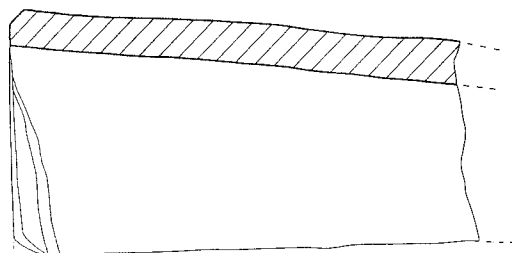
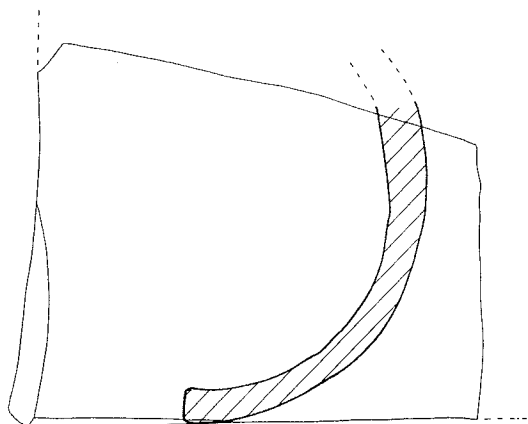

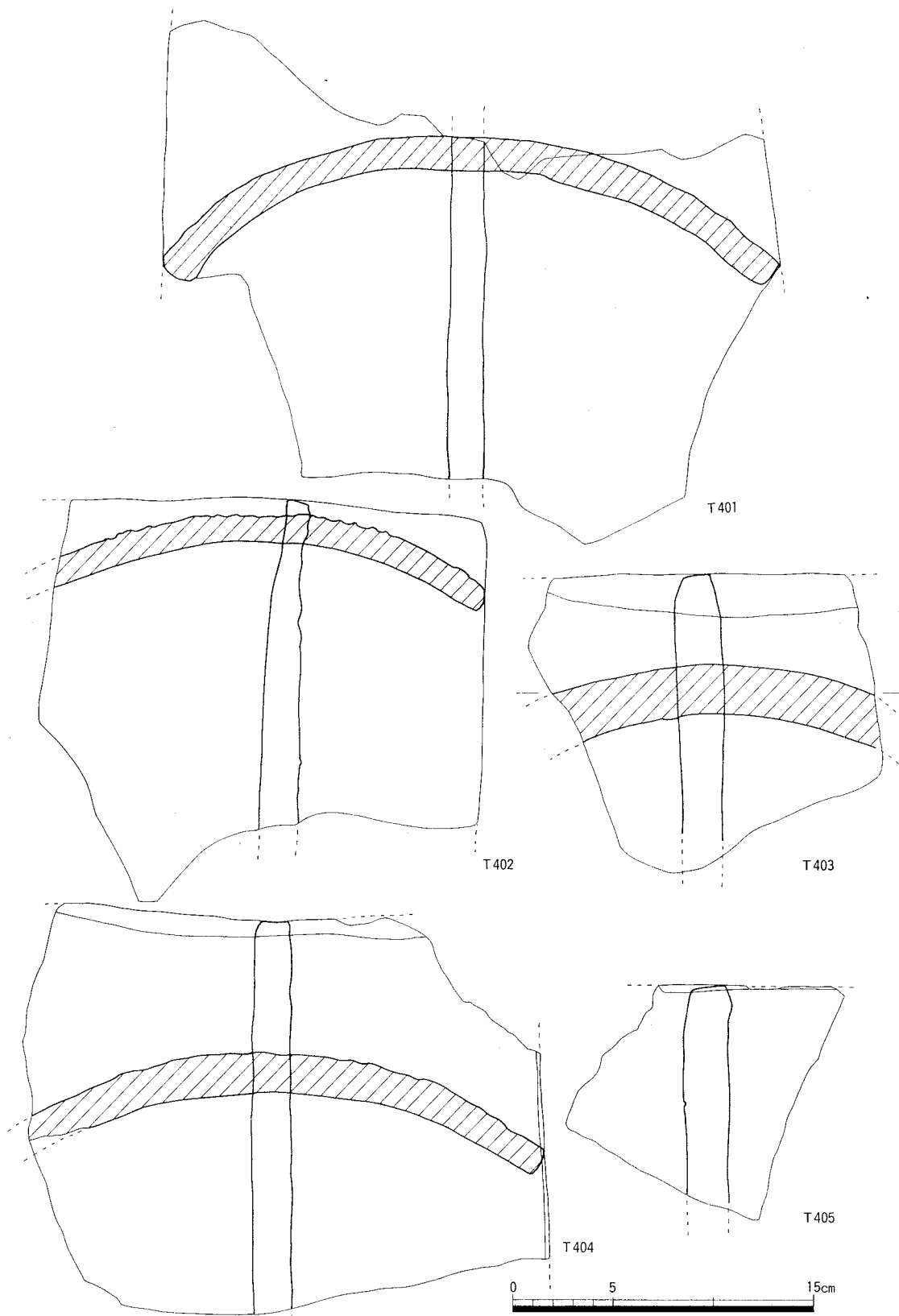

平瓦 (1:3)



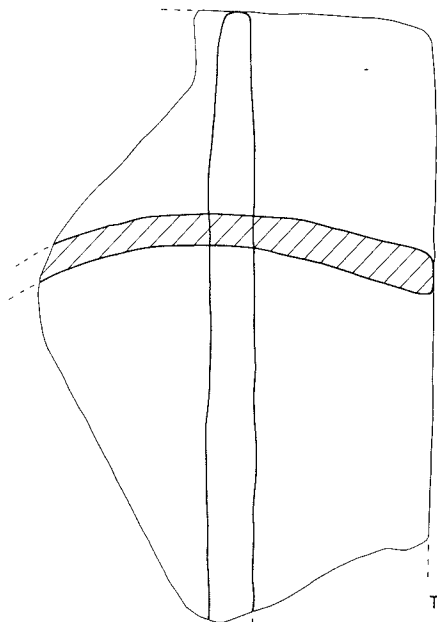

T406

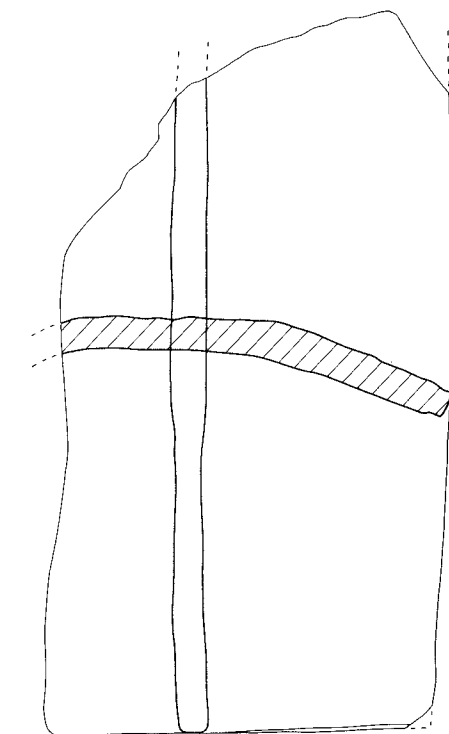

T407

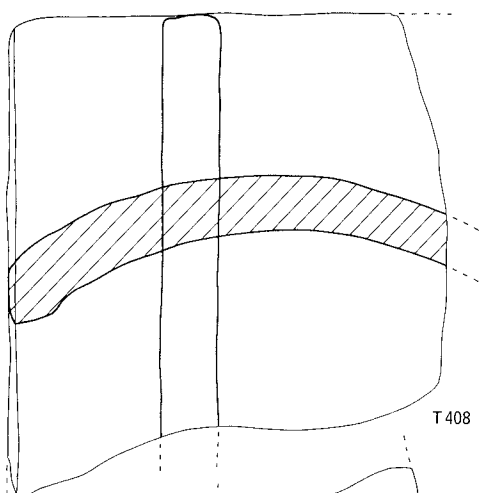

T408

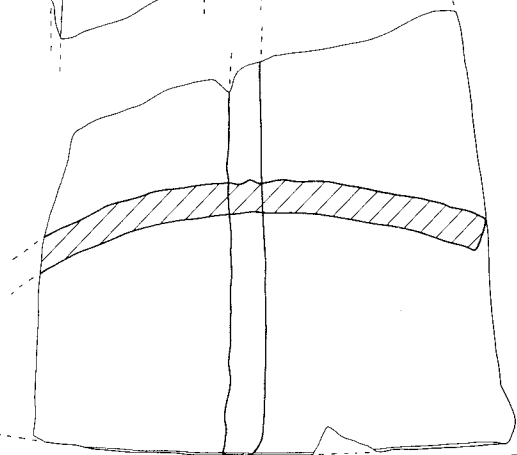

T409

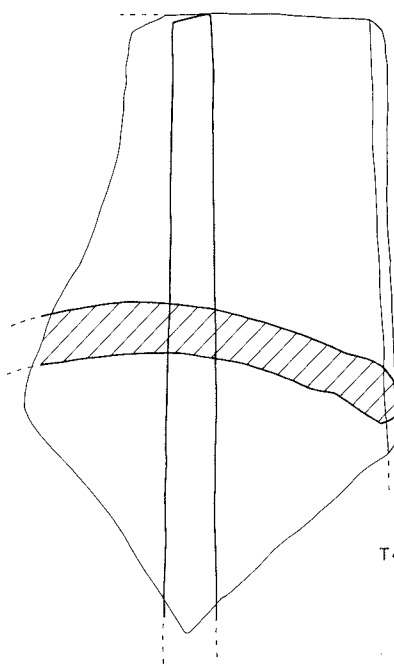

T410



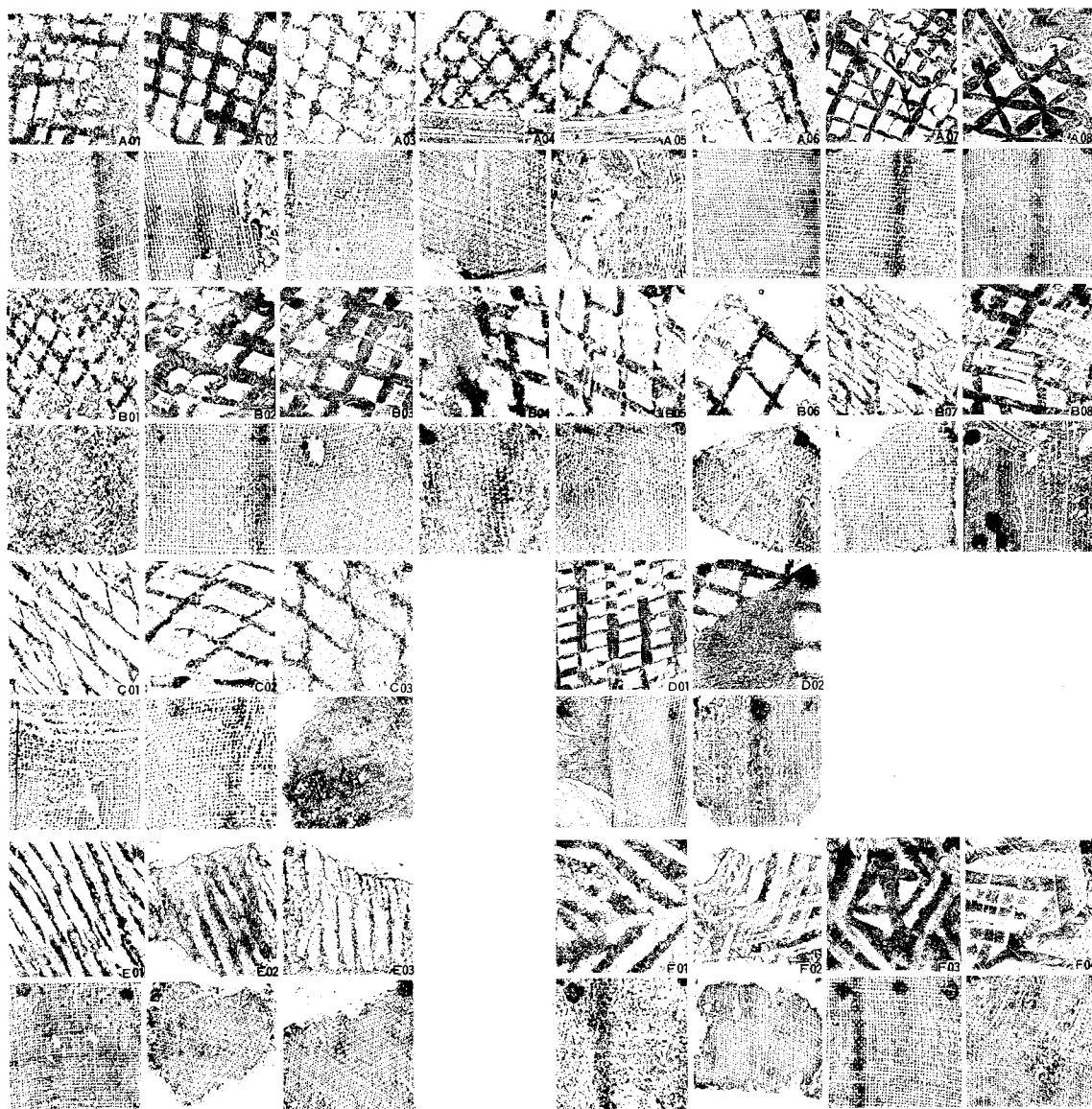

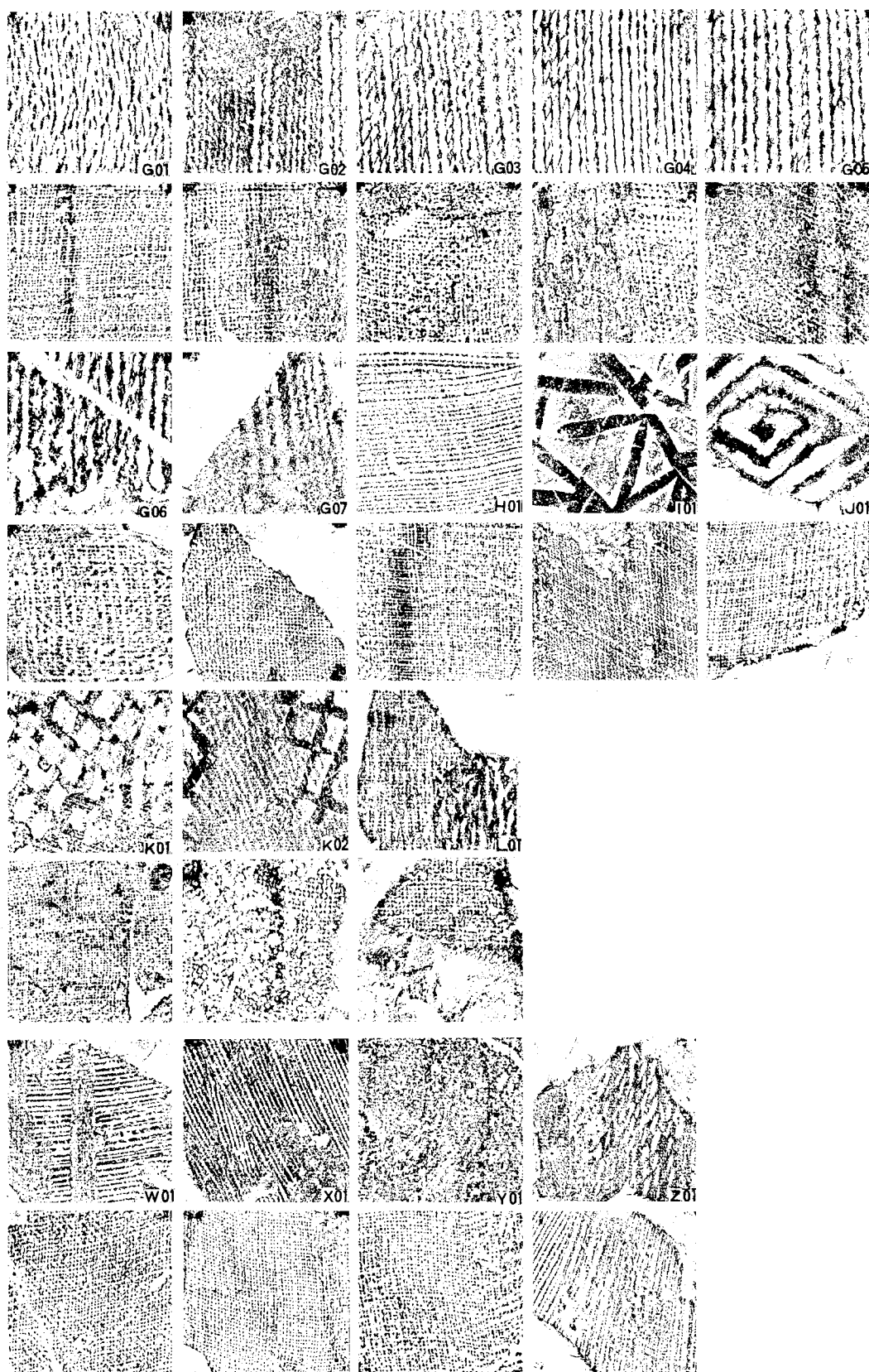

平瓦・丸瓦拓本 (1:2)

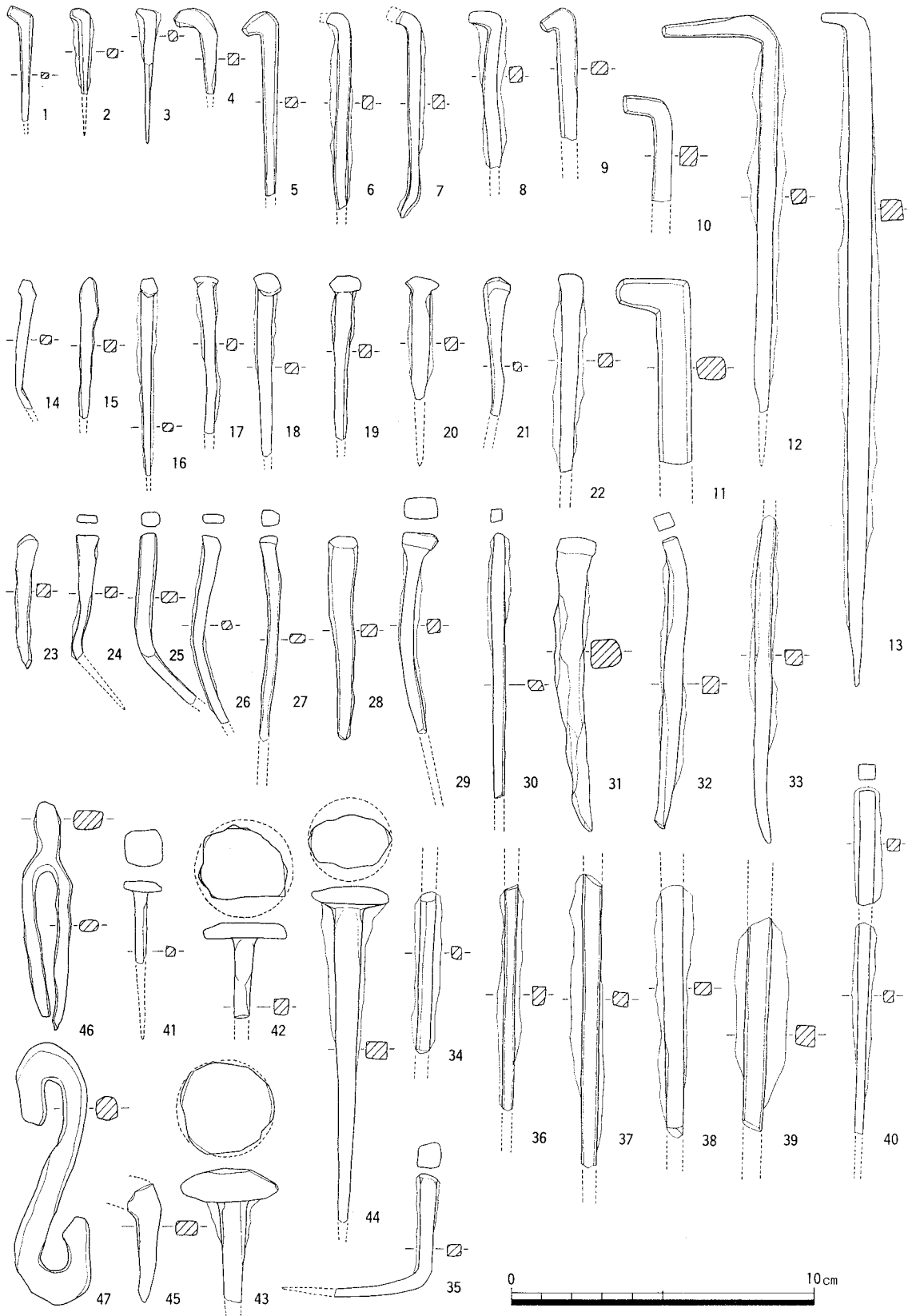

鉄釘・鉄製品 (1:2)

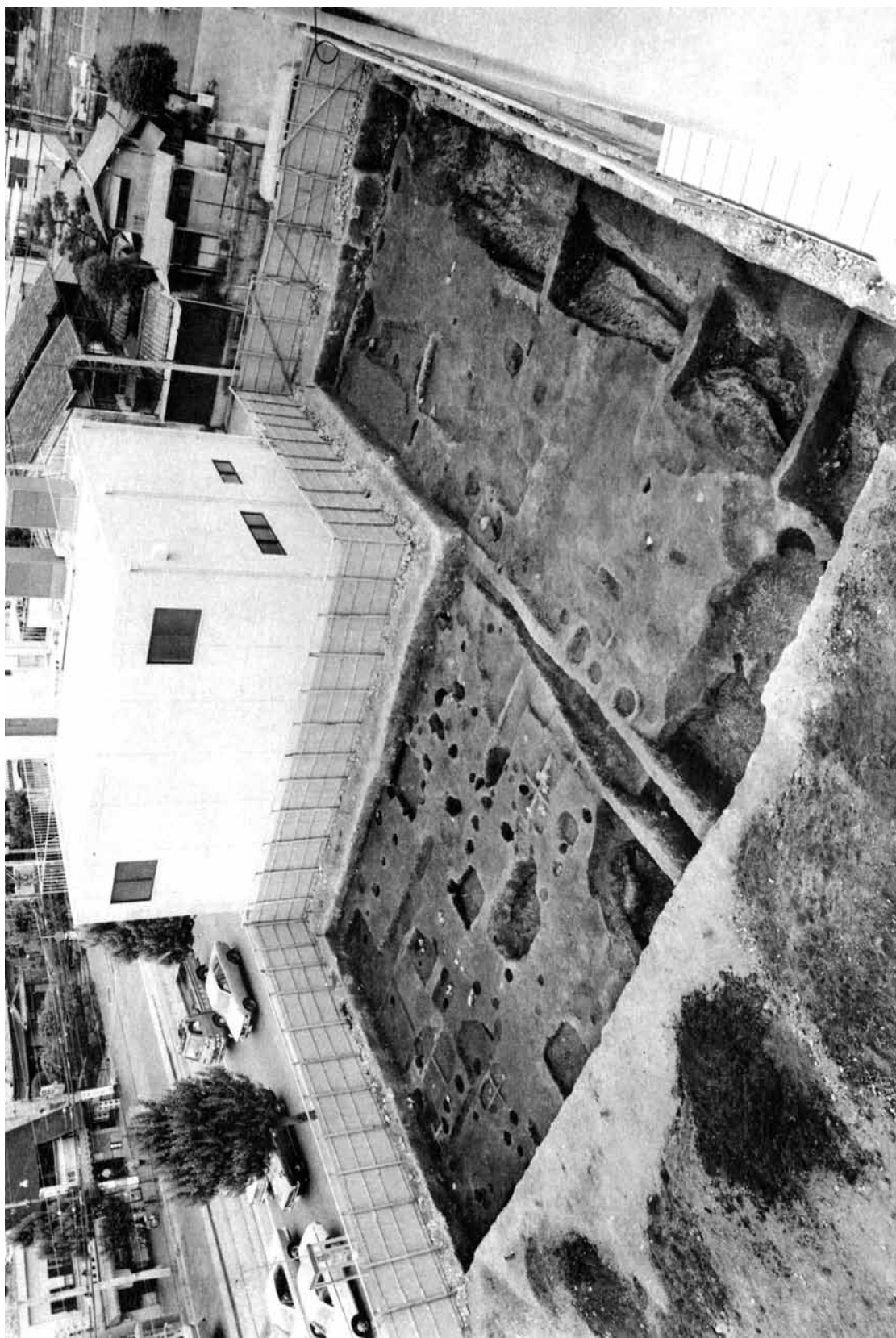

発掘区全景 (南東から)

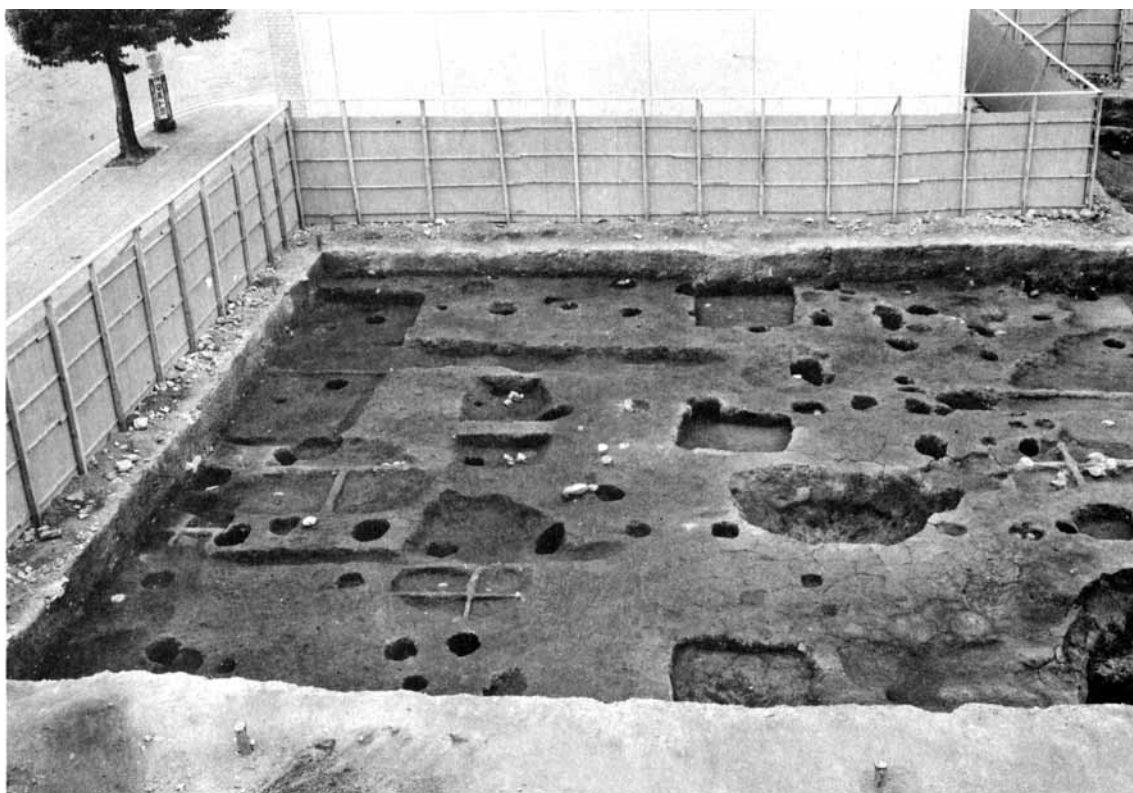

1 第3層遺構西部(南から)



2 第3層遺構東部(南西から)



1 SI56 竪穴住居 (南から)



2 発掘区南部土壙群



1 SD38 溝 (南から)



2 SD38 断面 (南から)





1 第 2 層遺構西部 (南から)

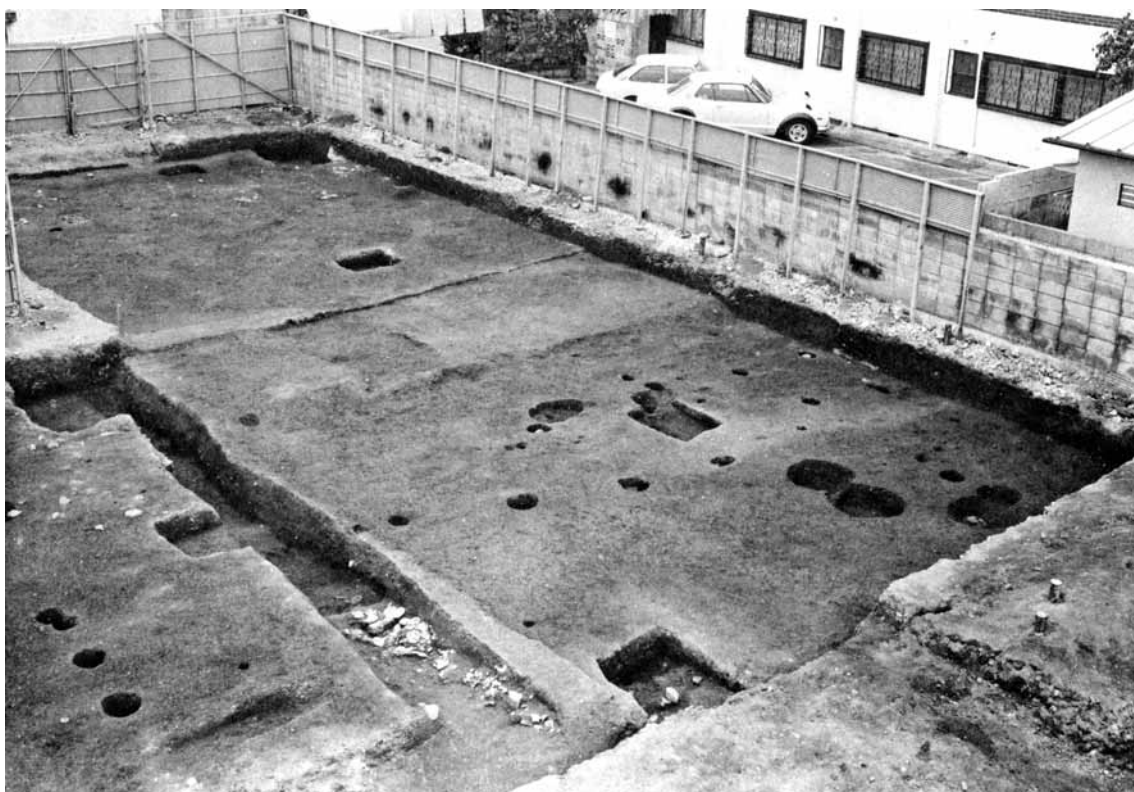

2 第 2 層遺構東部 (南西から)

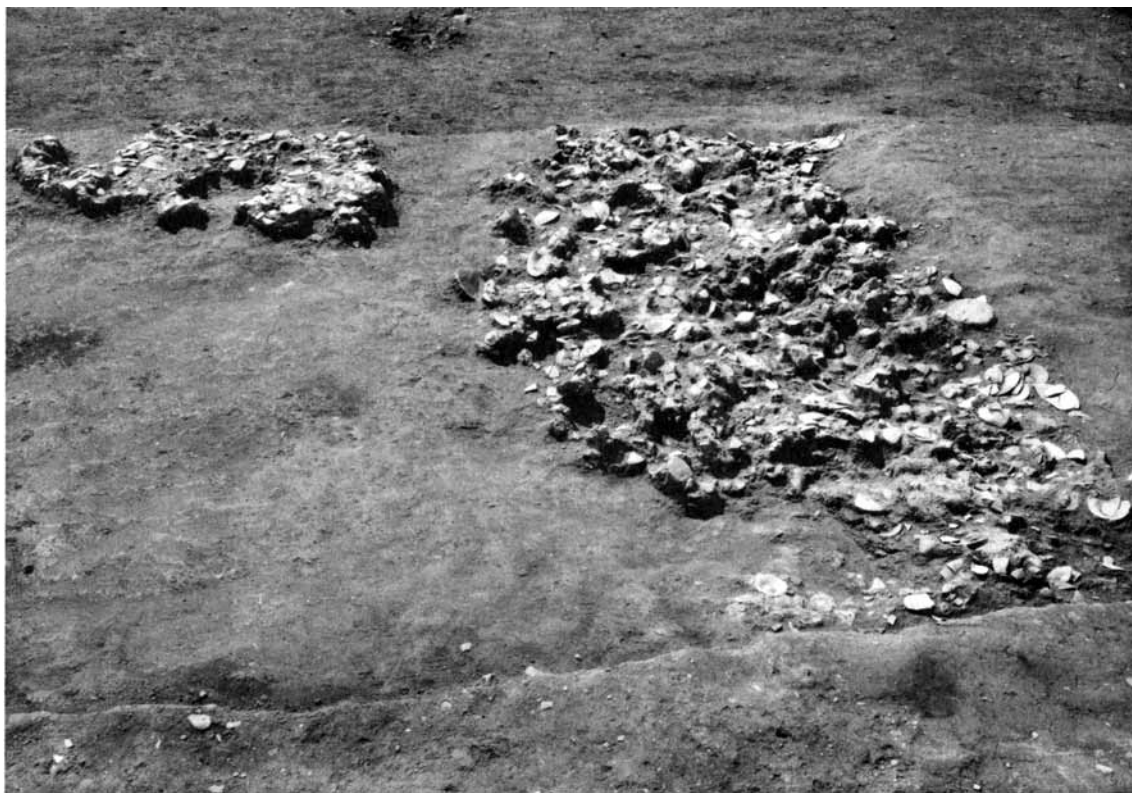

1 SK01 土器溜 (北から)

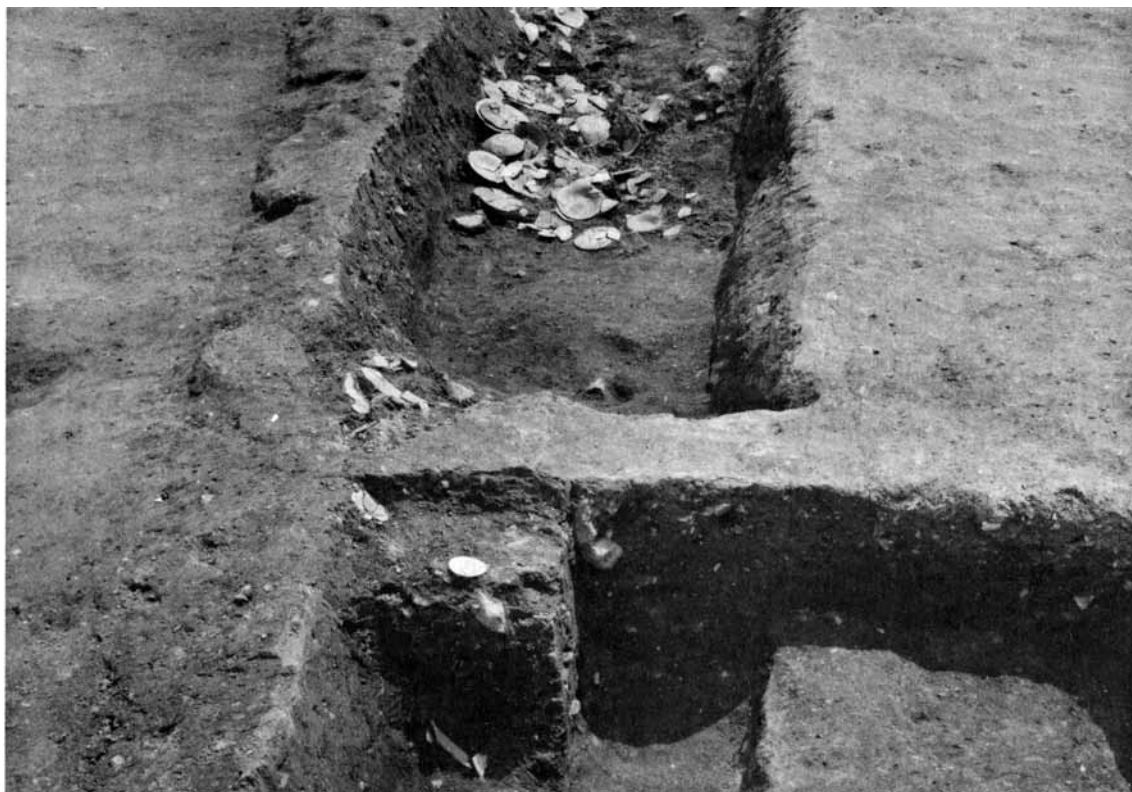

2 SD04 溝出土土器群 (北から)



SI56 出土土器 1 ~ 5、SD38 下層出土土器 8 ~ 33

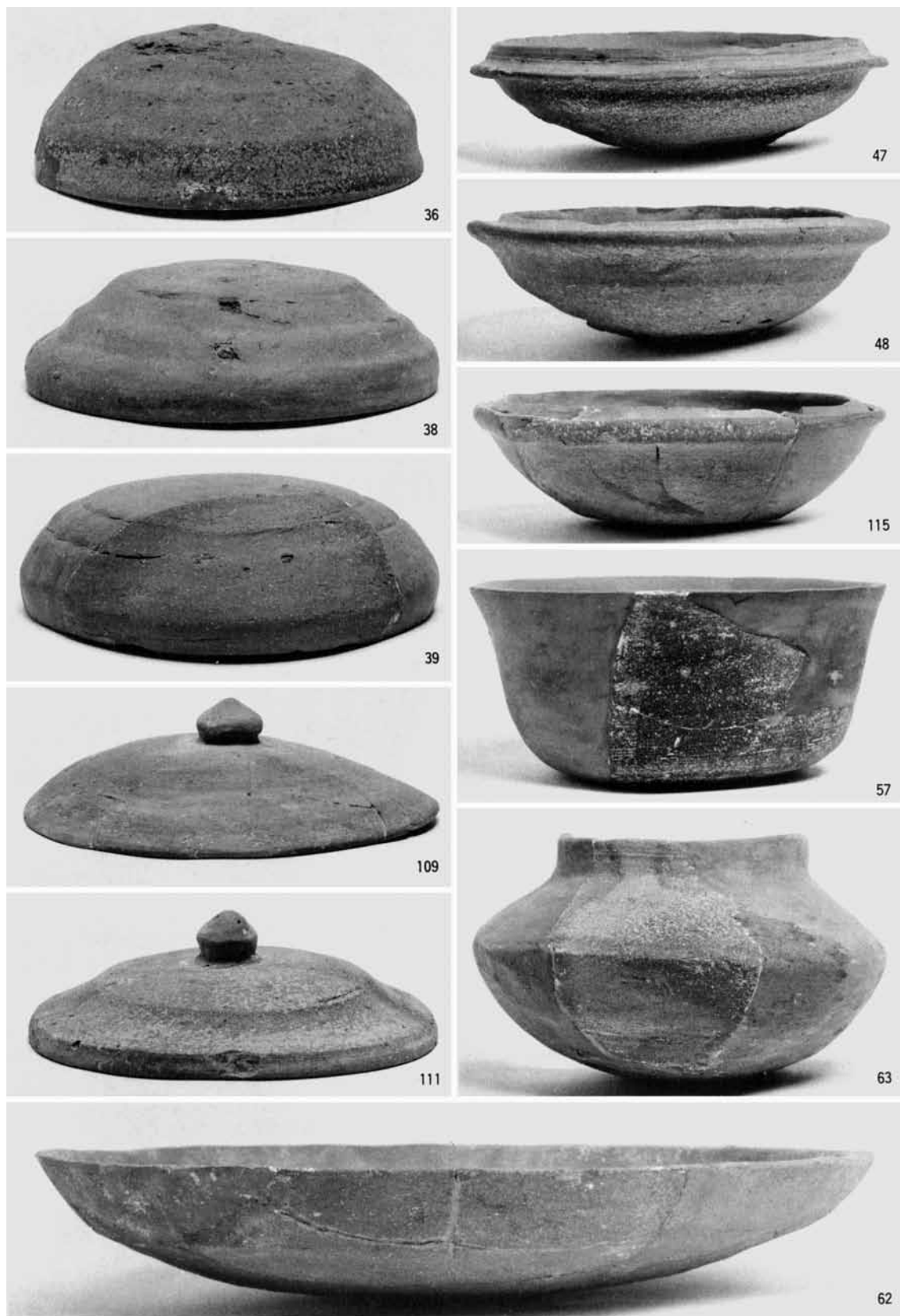

SD38 下層出土土器 36 ~ 63、SD38 中層出土土器 109 ~ 115



2D38 中層甲干干器 81 ~ 105' 2D38 下層甲干干器 135 ~ 128

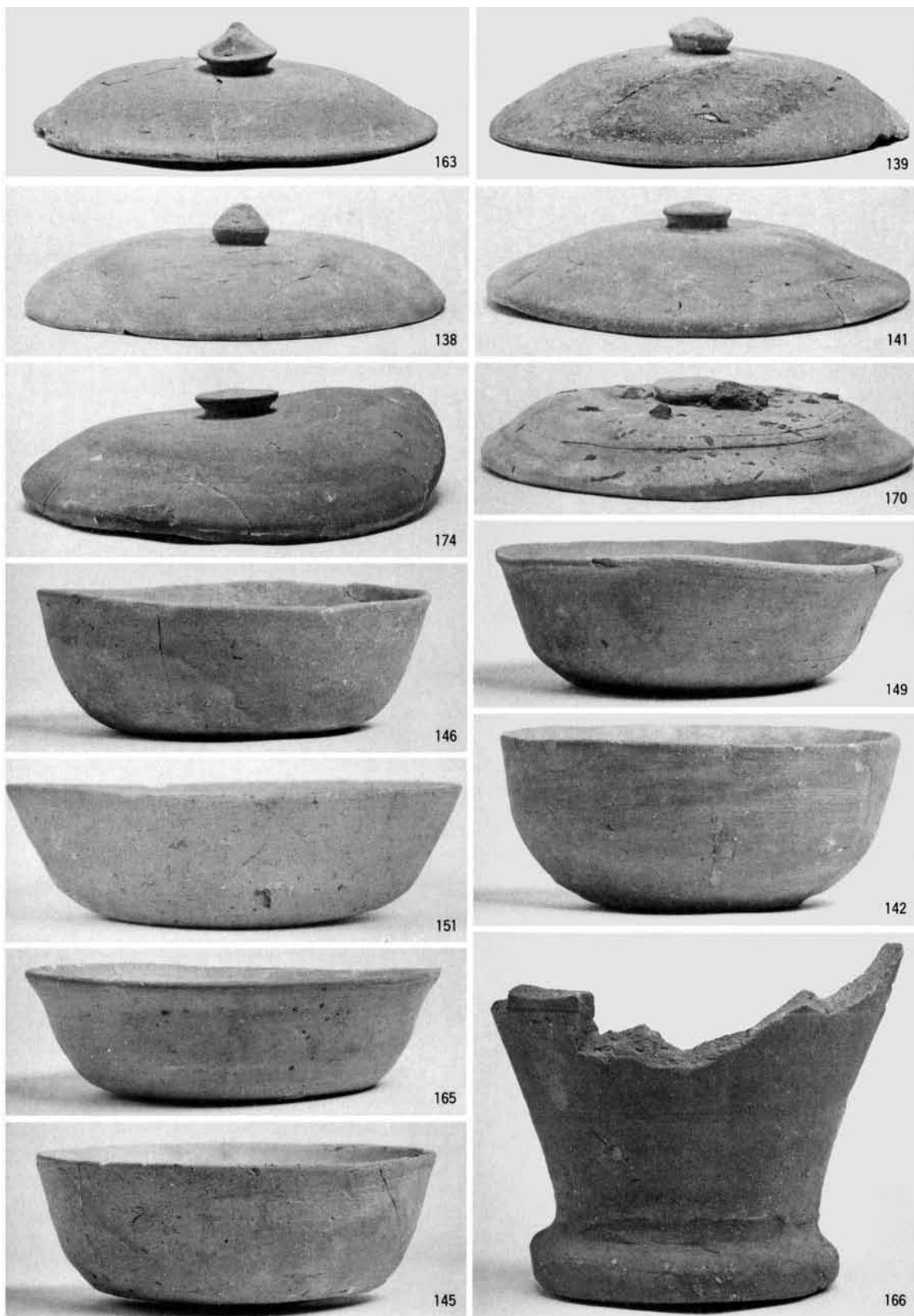

SD38 上層出土土器 138 ~ 151、SD37 出土土器 163 ~ 166、SK34・35 出土土器 170・174



SK23 出土土器 177 ~ 206、SK21 出土土器 220 ~ 229



SK20 出土土器





SK20 出土土器 283 ~ 300、SK13 第 4 層出土土器 329 ~ 358



SD13 第 4 層出土土器

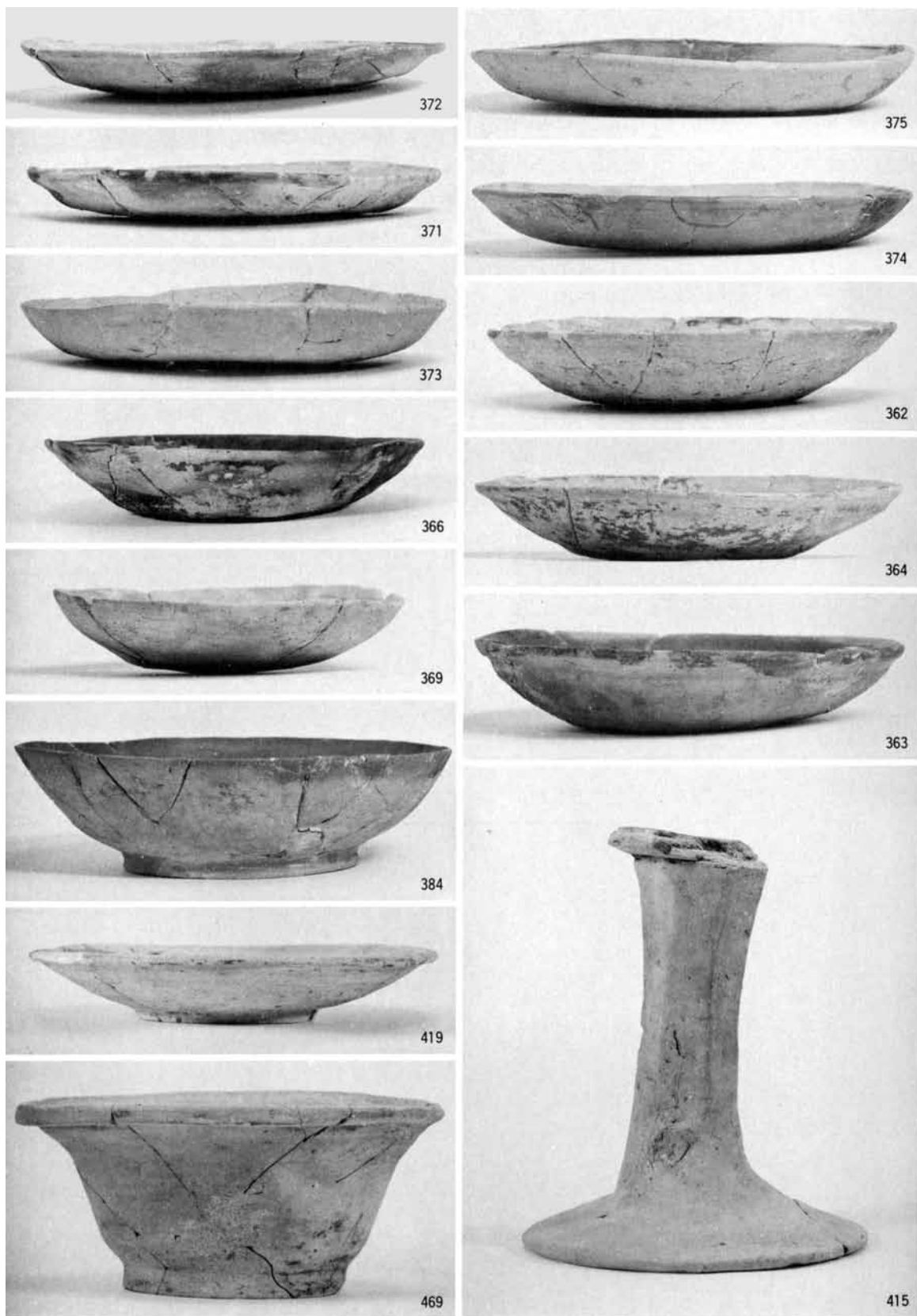

SD12 出土土器 362 ~ 384、SK18 出土土器 415・419、SK22 出土土器 469



SD14 出土土器

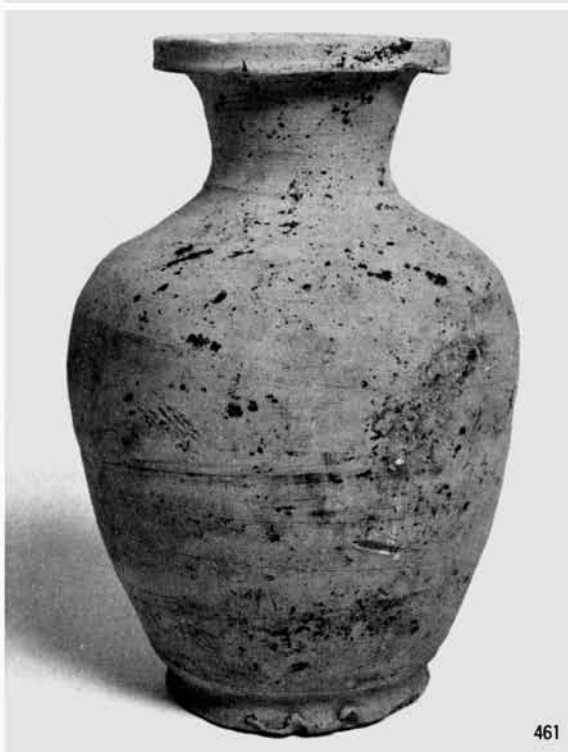

SD14 出土土器



SK01 出土土器 510 ~ 517、SD04 出土土器 522 ~ 531、SX08 出土土器 542・543

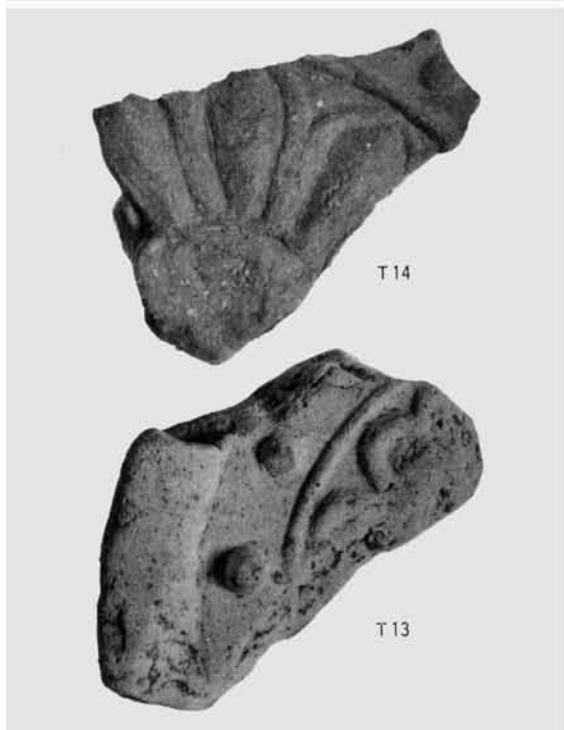

軒丸瓦



軒丸瓦







鉄釘・鉄製品