

1区第1面遺構平面図(1:150)

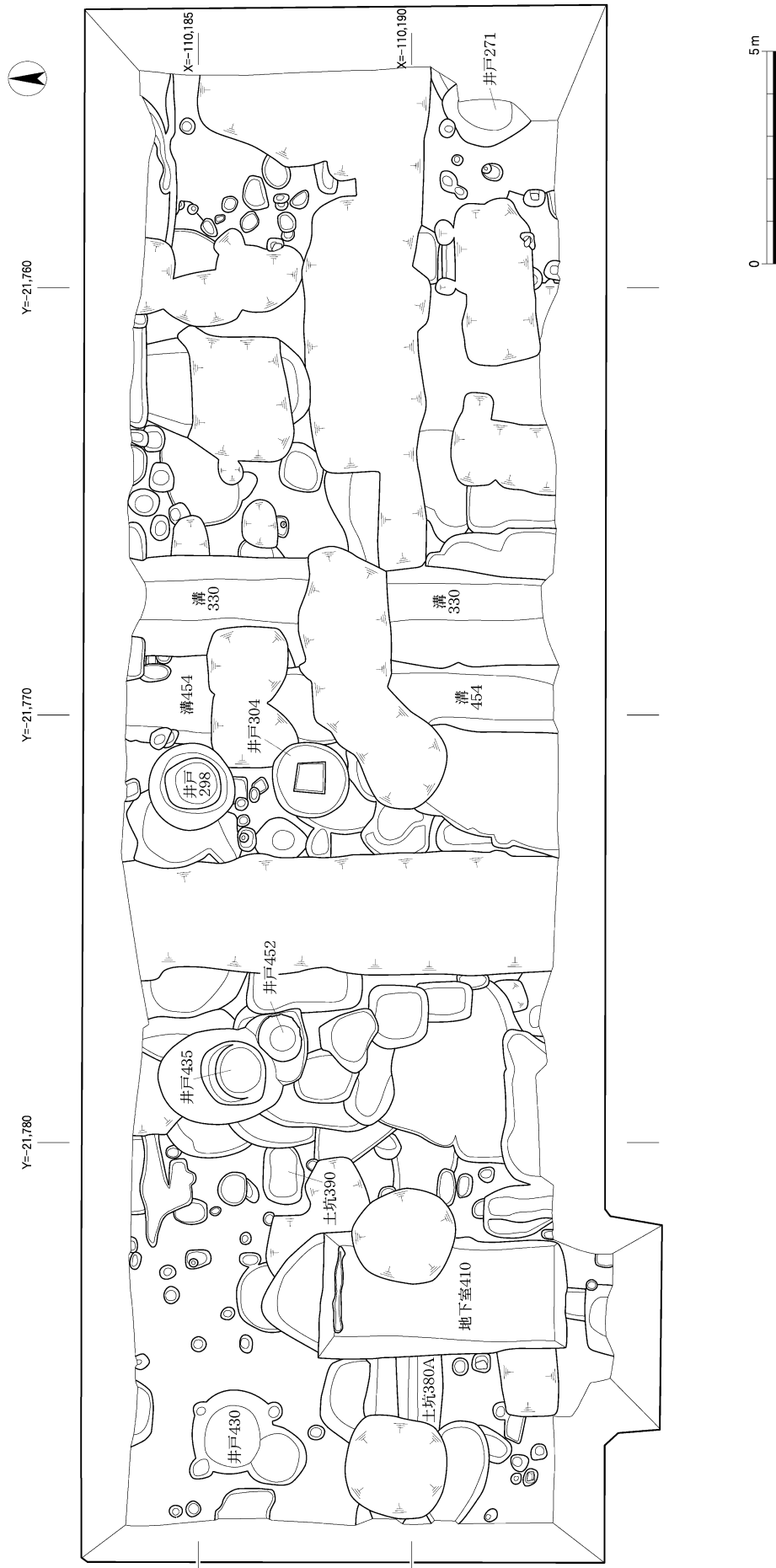

1区第2面遺構平面図(1:150)

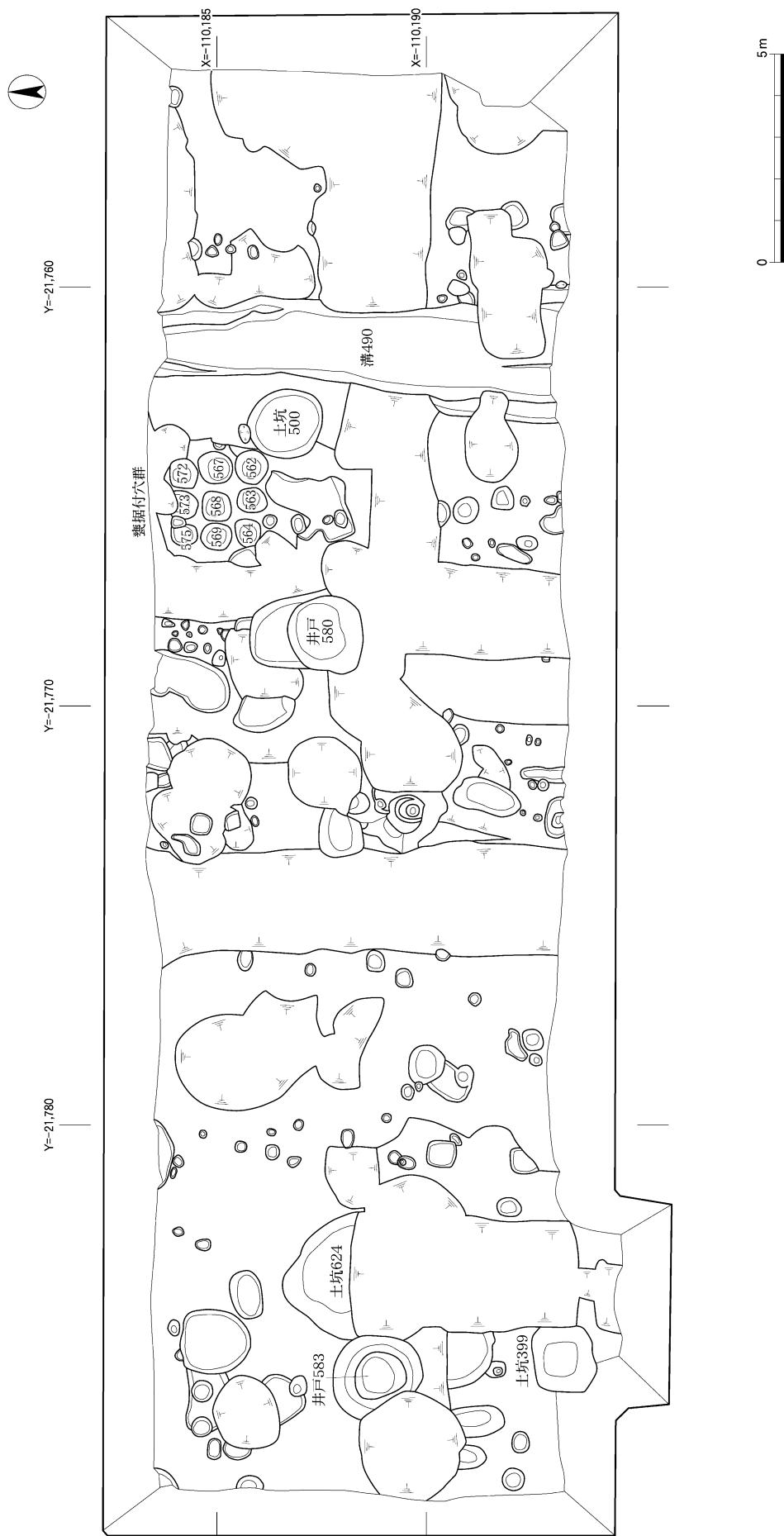

1区第3面遺構平面図 (1:150)

図版 4
遺構

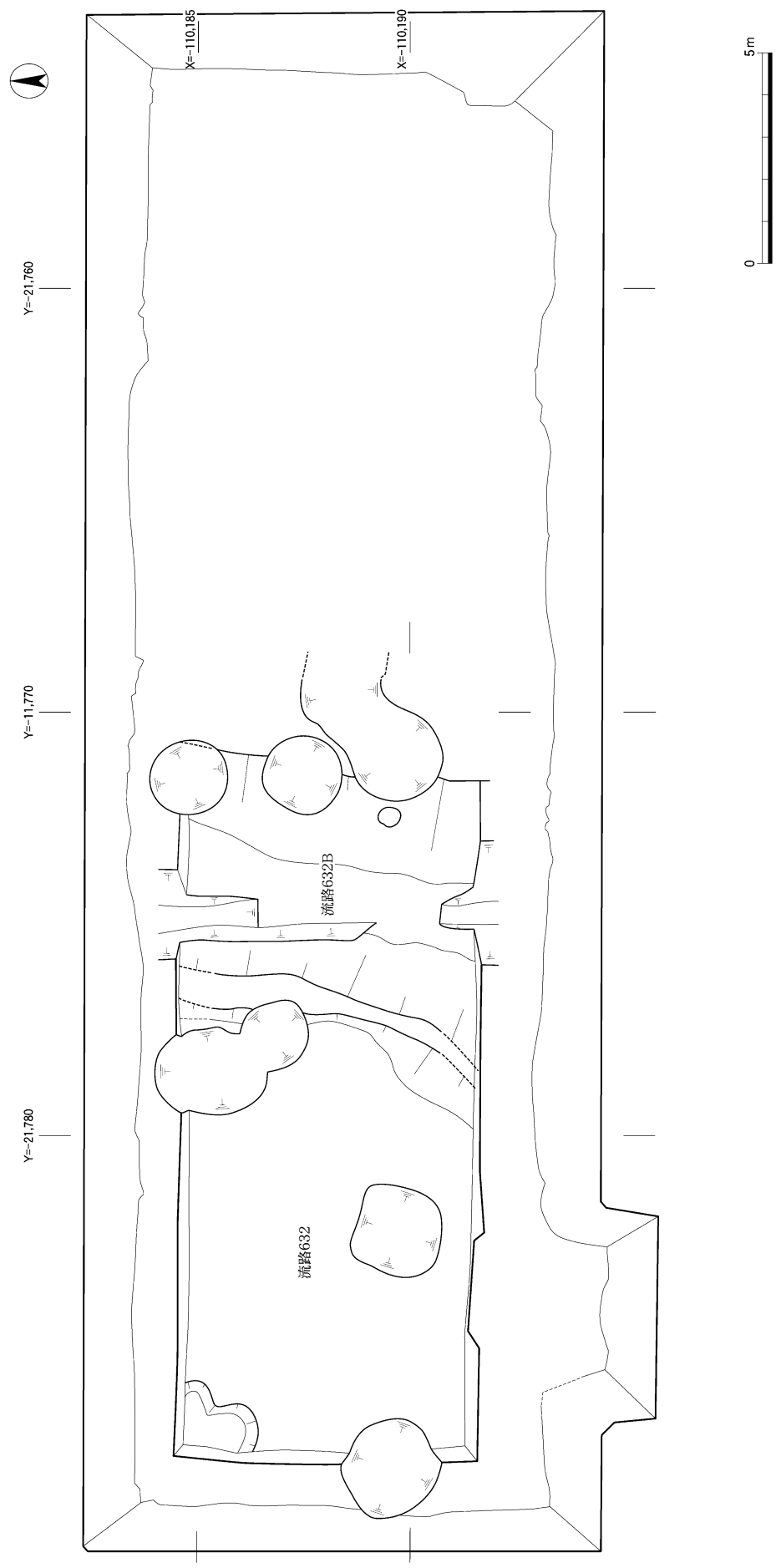

1区第4面遺構平面図 (1 : 150)

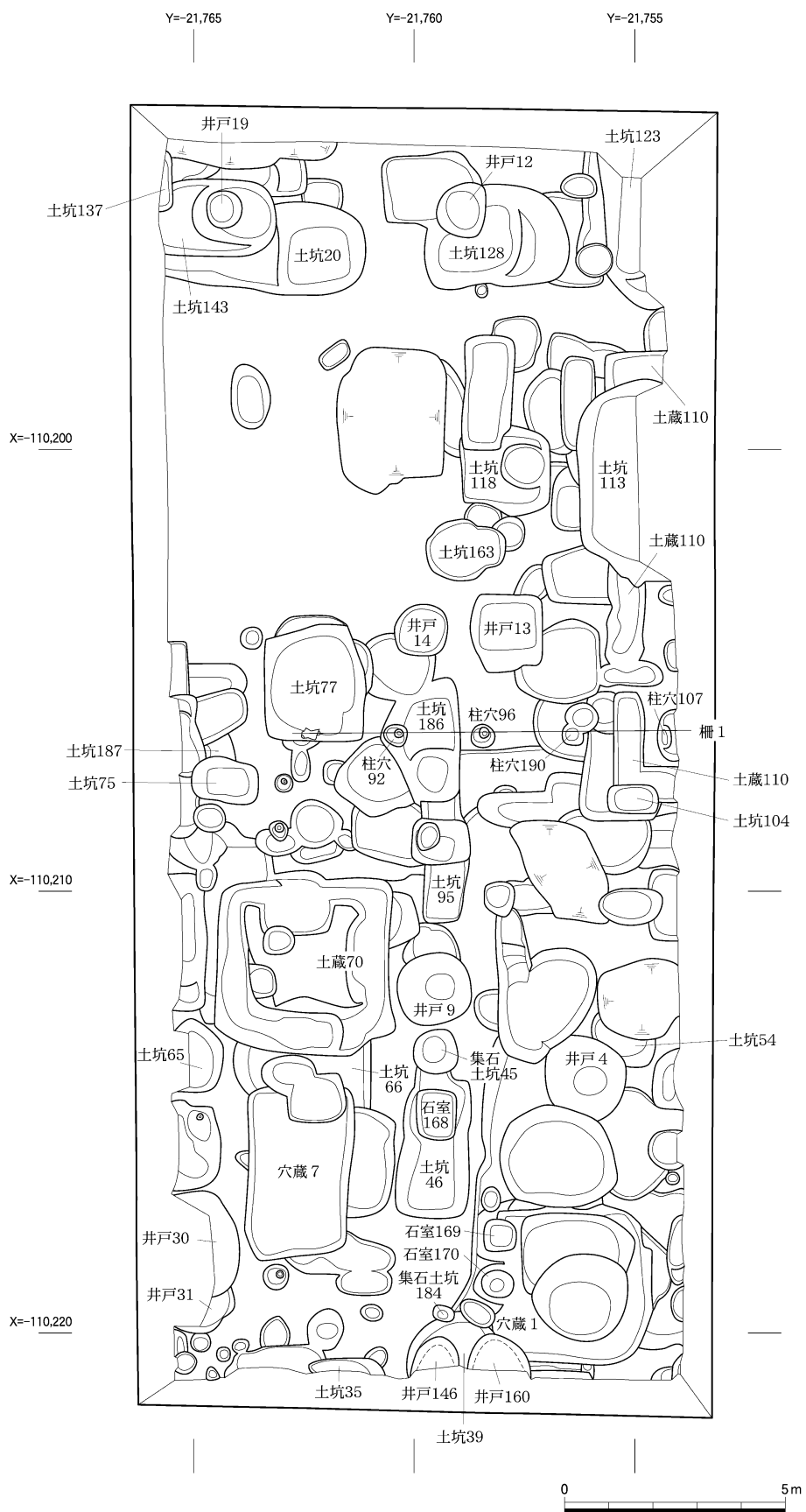

2区第1面遺構平面図 (1 : 150)

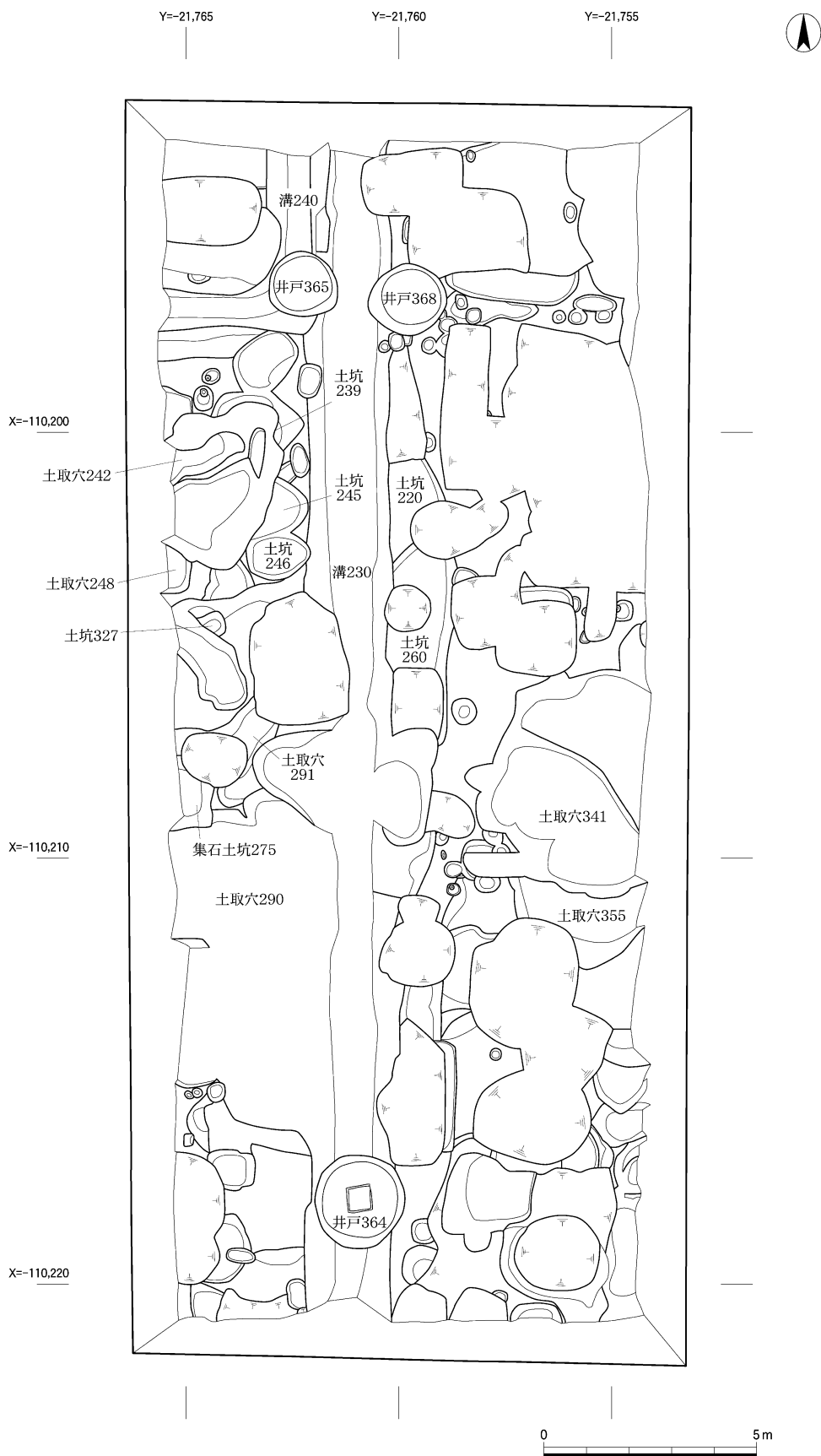

2区第2面遺構平面図 (1 : 150)

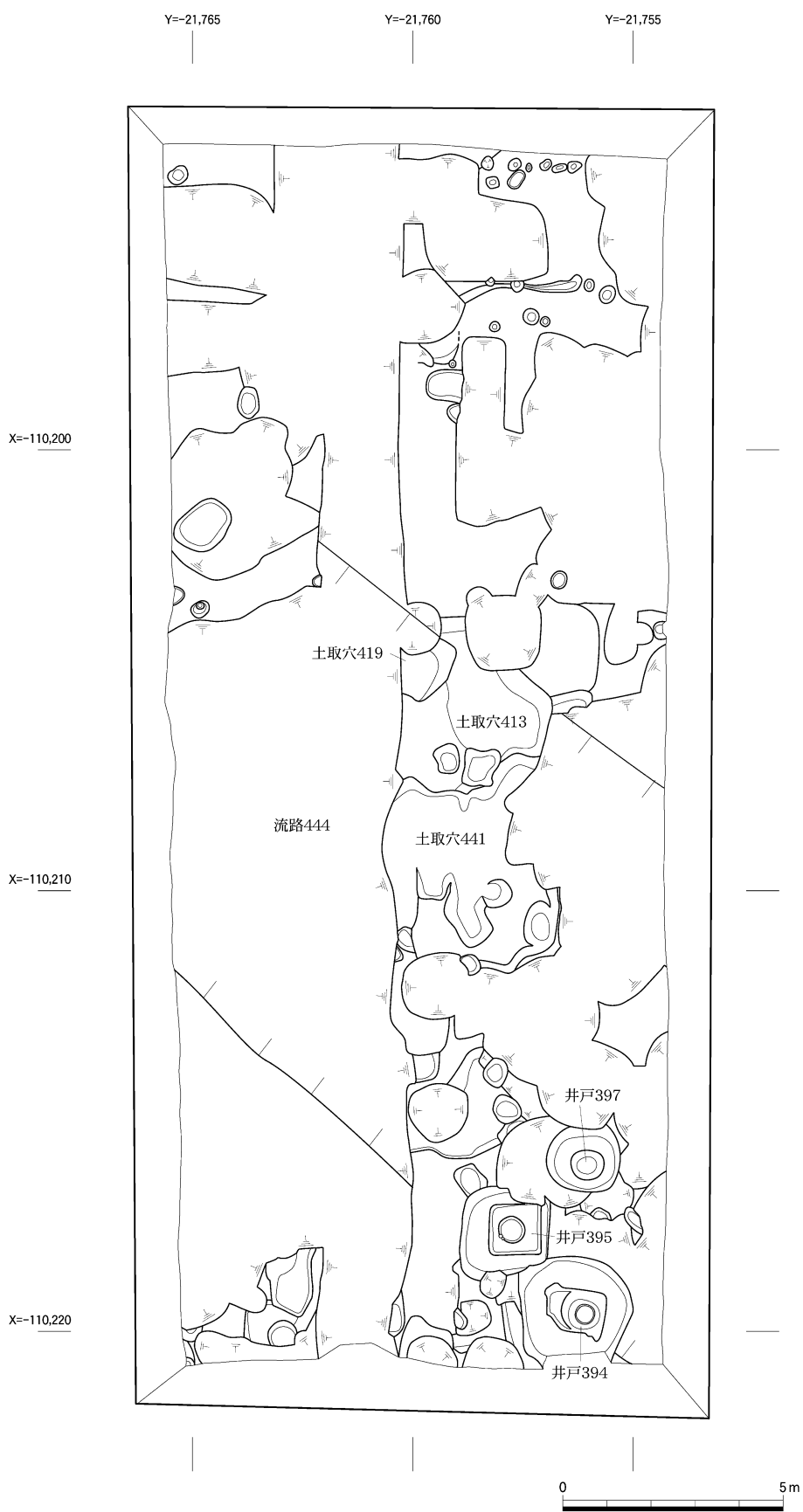

2区第3面遺構平面図 (1 : 150)

弥生土器

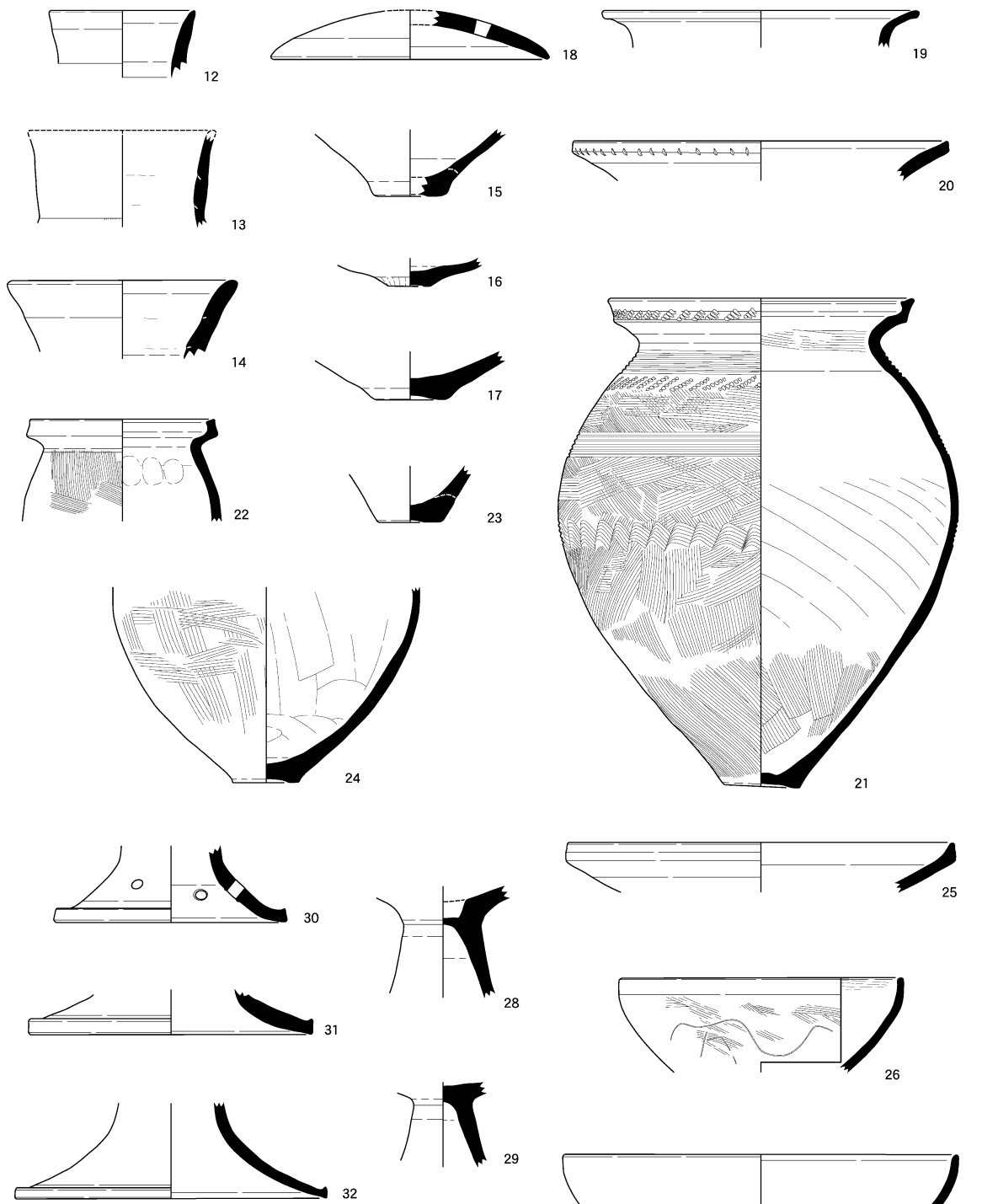

土師器

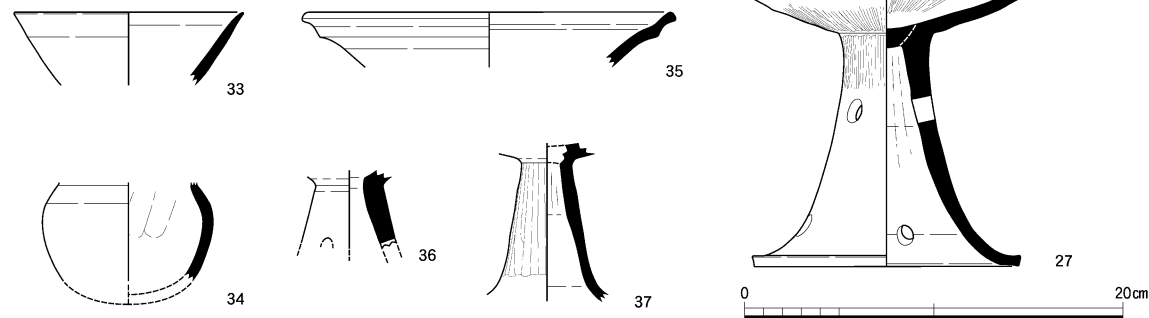

土器実測図1 (1:4)

2区 井戸394

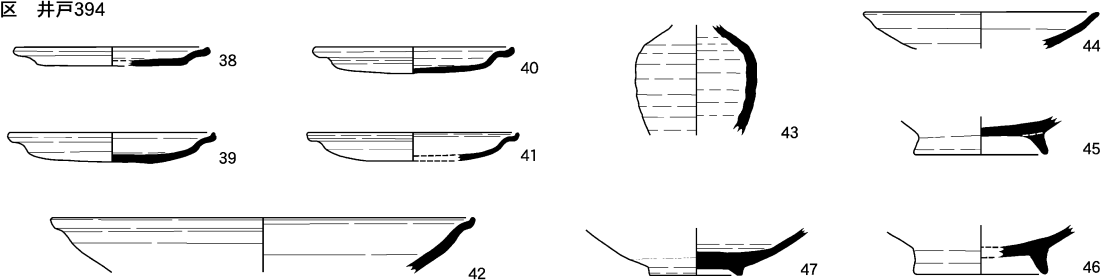

2区 井戸395

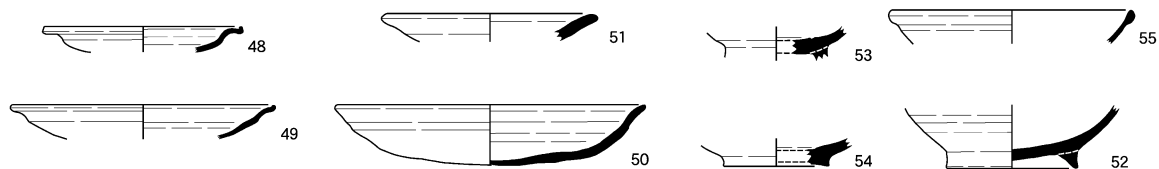

1区 井戸583

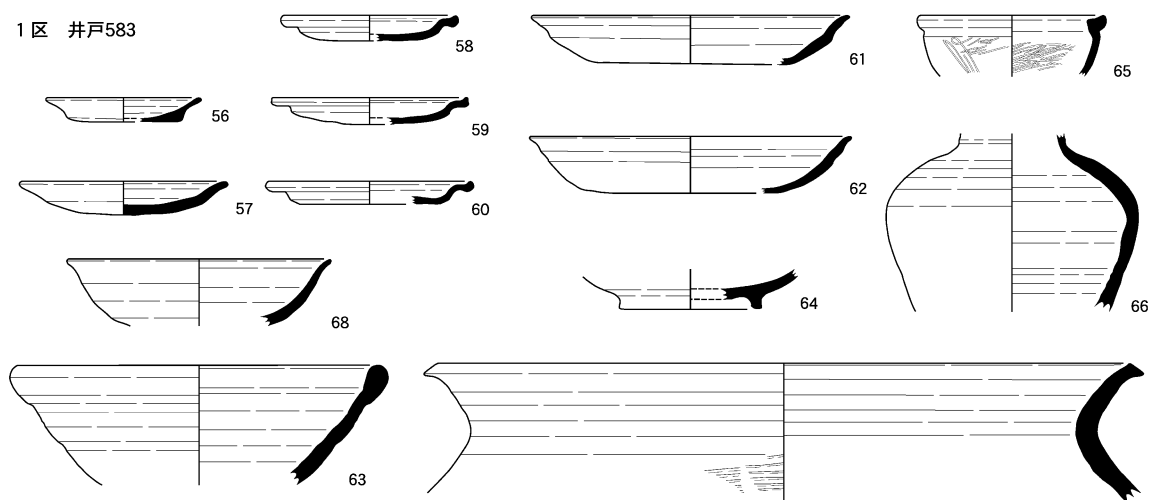

1区 土坑399

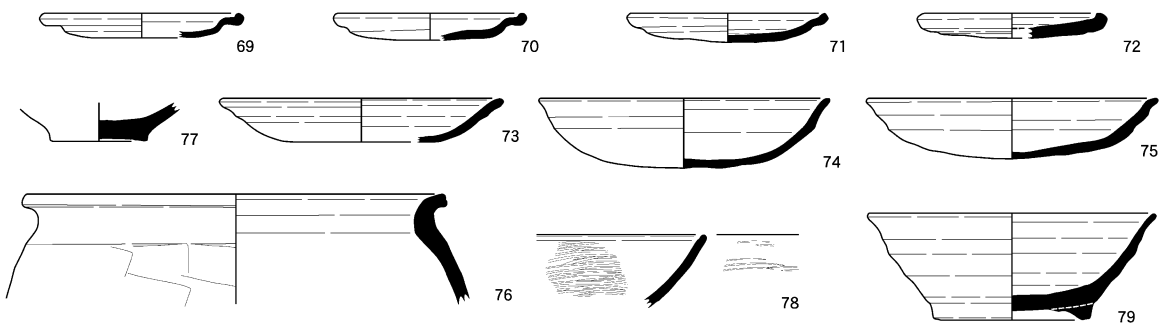

1区 土坑500

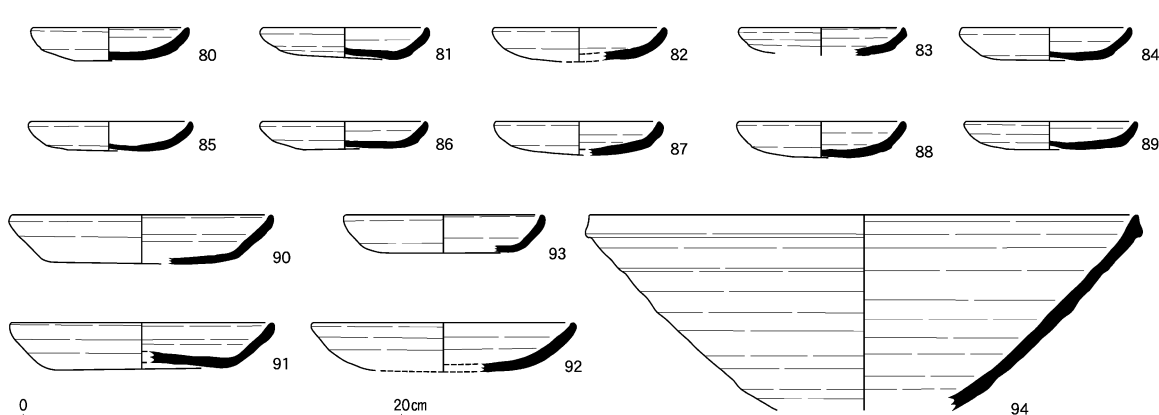

土器実測図2 (1:4)

1区 土坑390

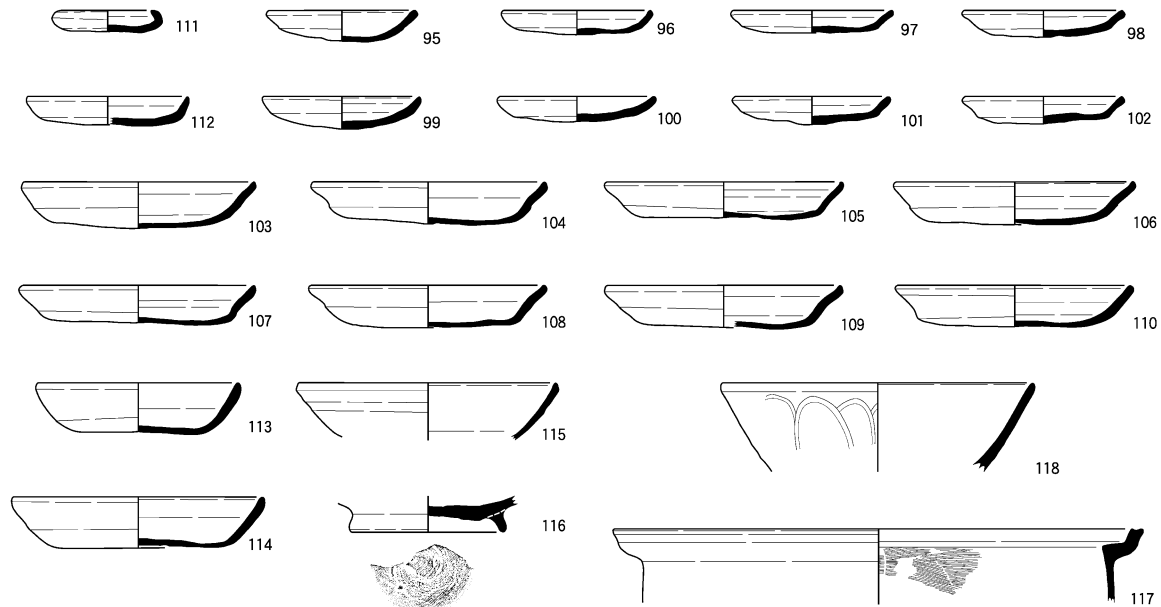

1区 井戸304

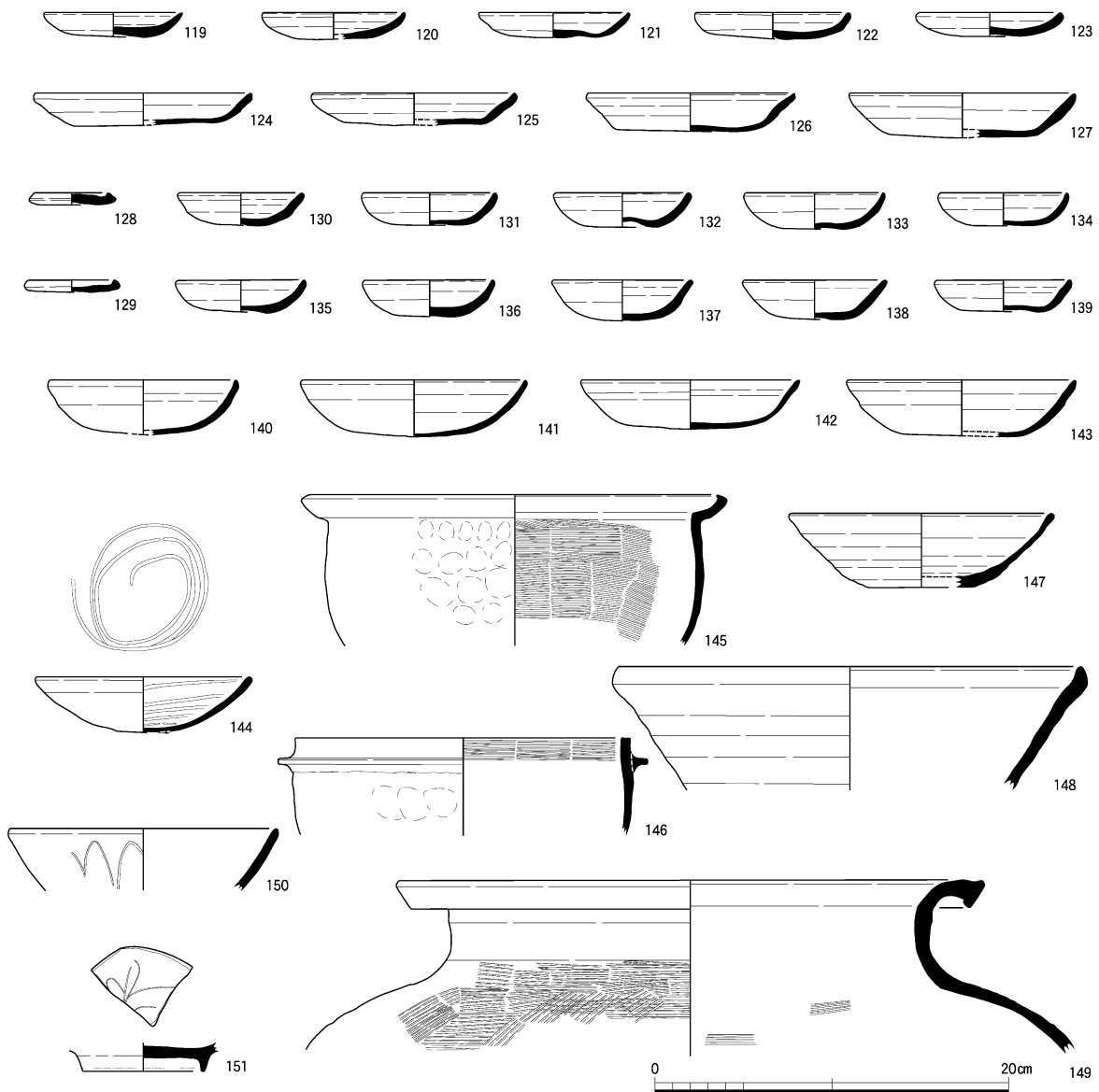

土器実測図3 (1:4)

1区 地下室410

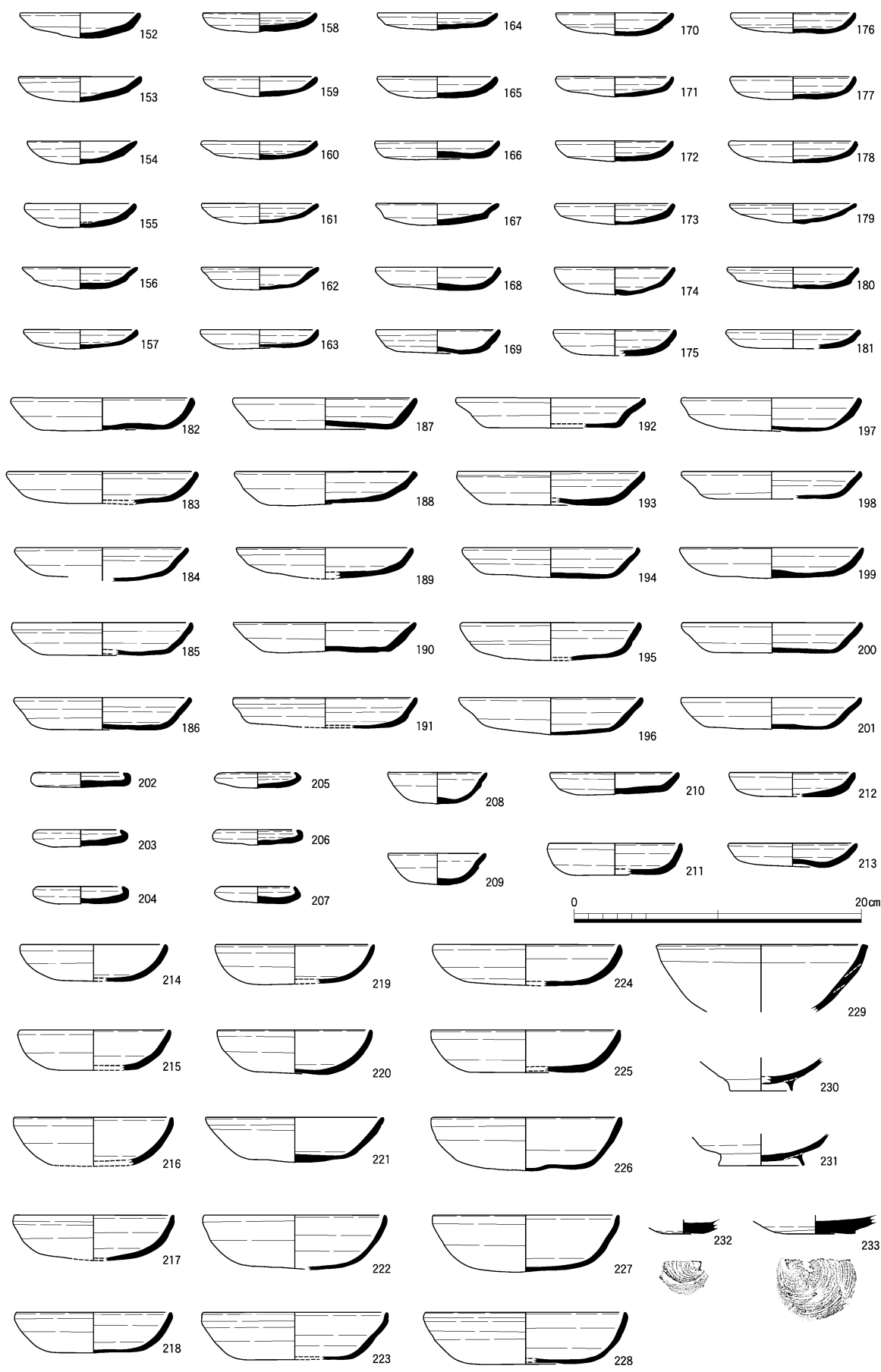

土器実測図4 (1:4)

1区 地下室410

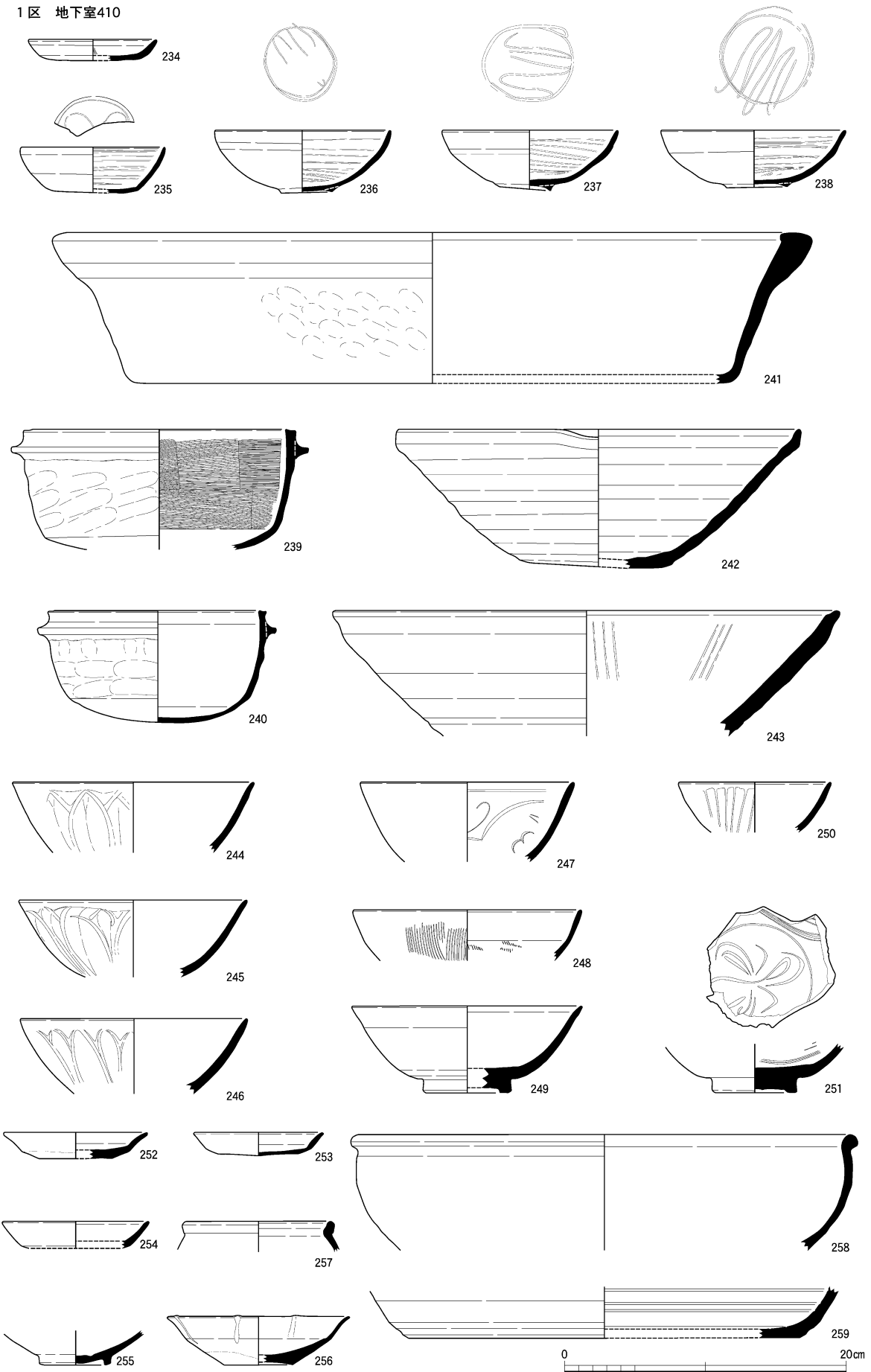

土器実測図5 (1:4)

1区 井戸452

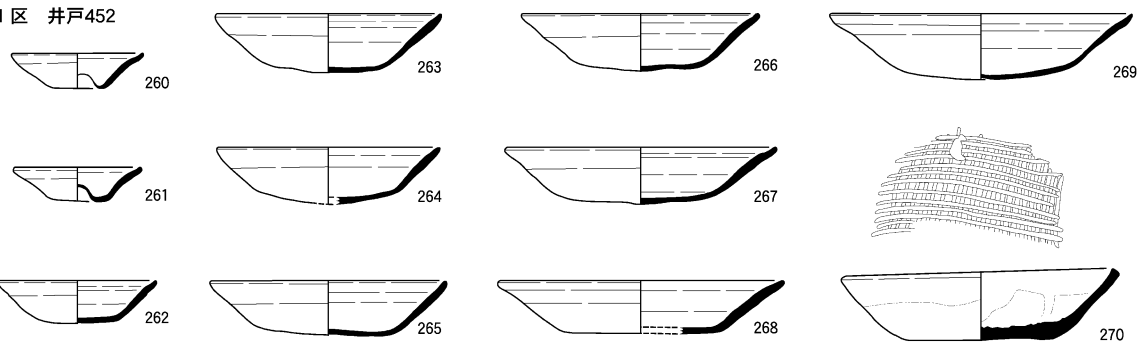

1区 土坑380A

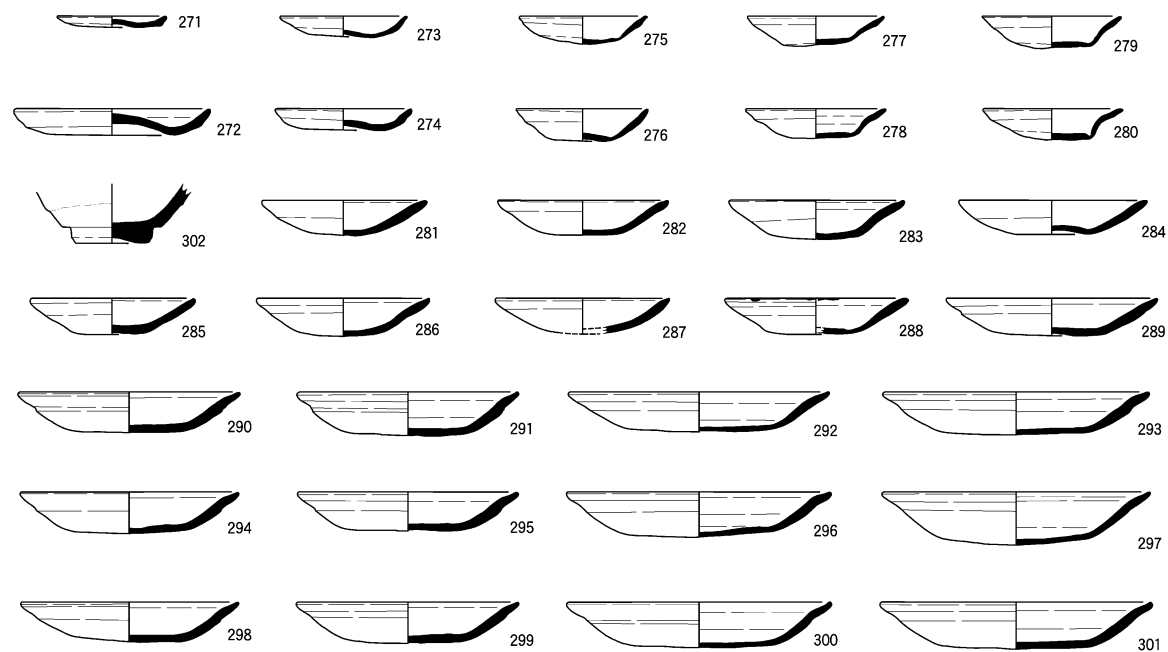

2区 溝230

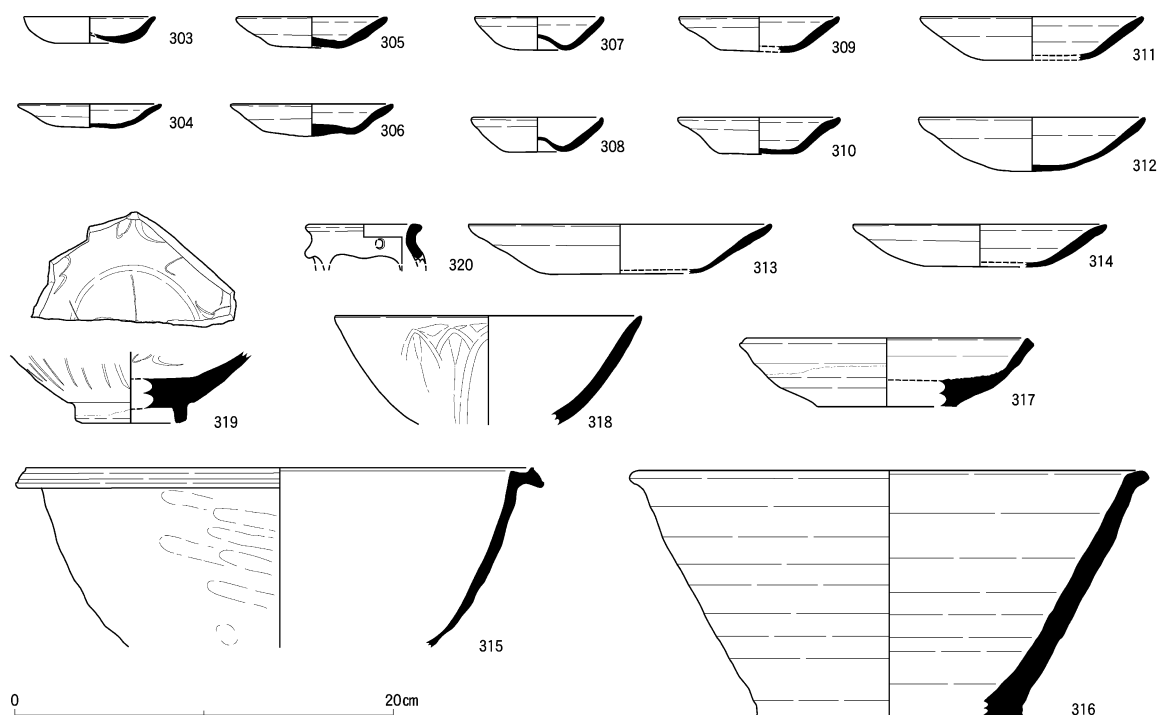

土器実測図6 (1:4)

1区 溝160

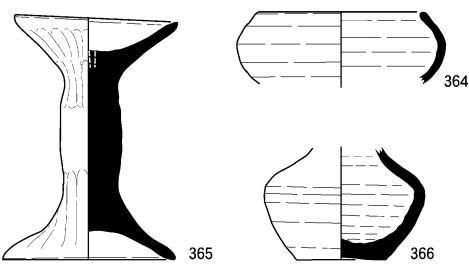
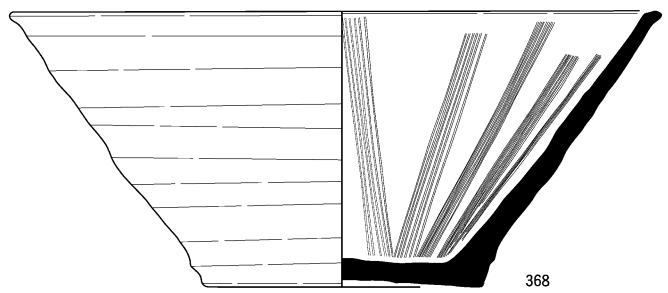
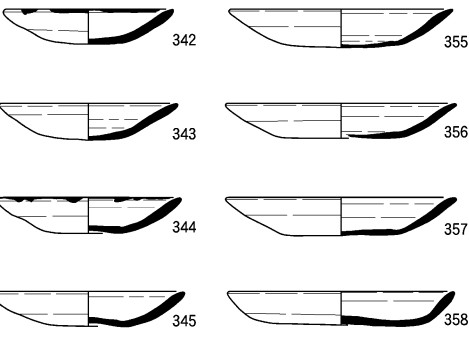
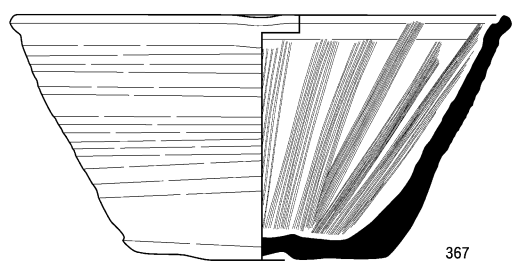
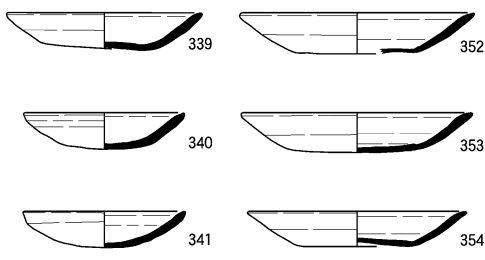
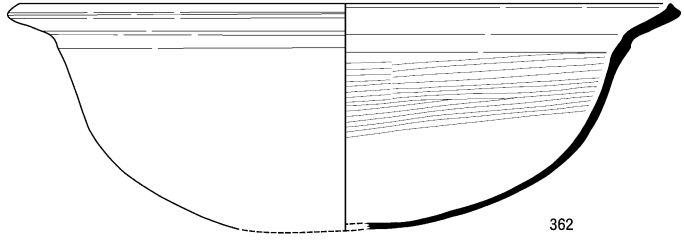
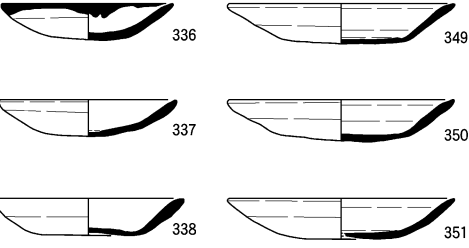
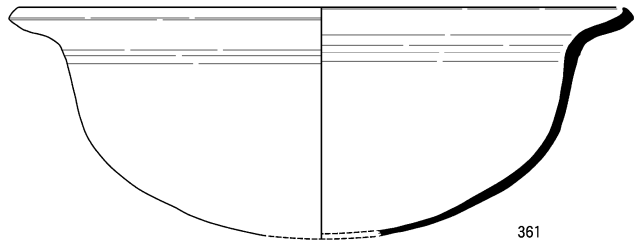
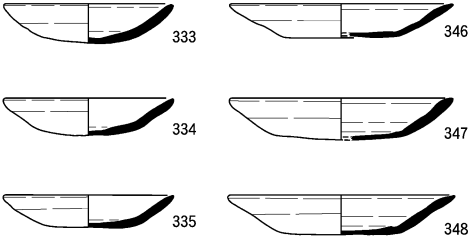
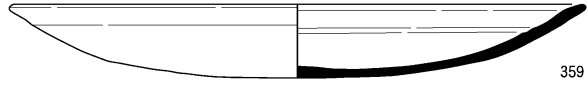
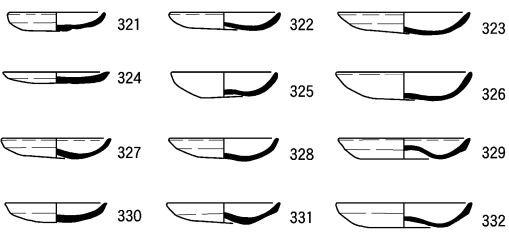

土器実測図7 (1:4)

1区 溝160

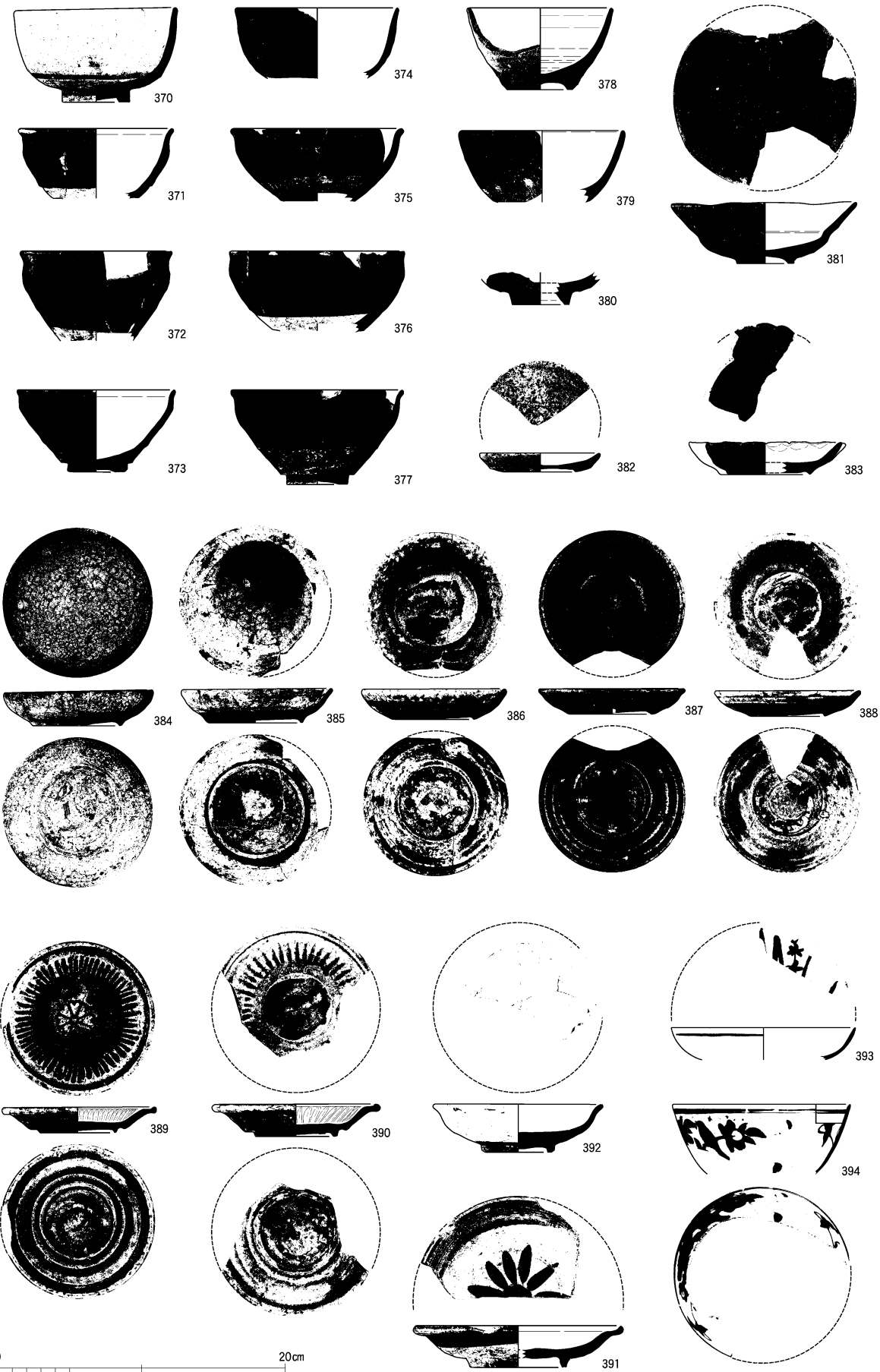

土器実測図8 (1:4)

1区 土坑45

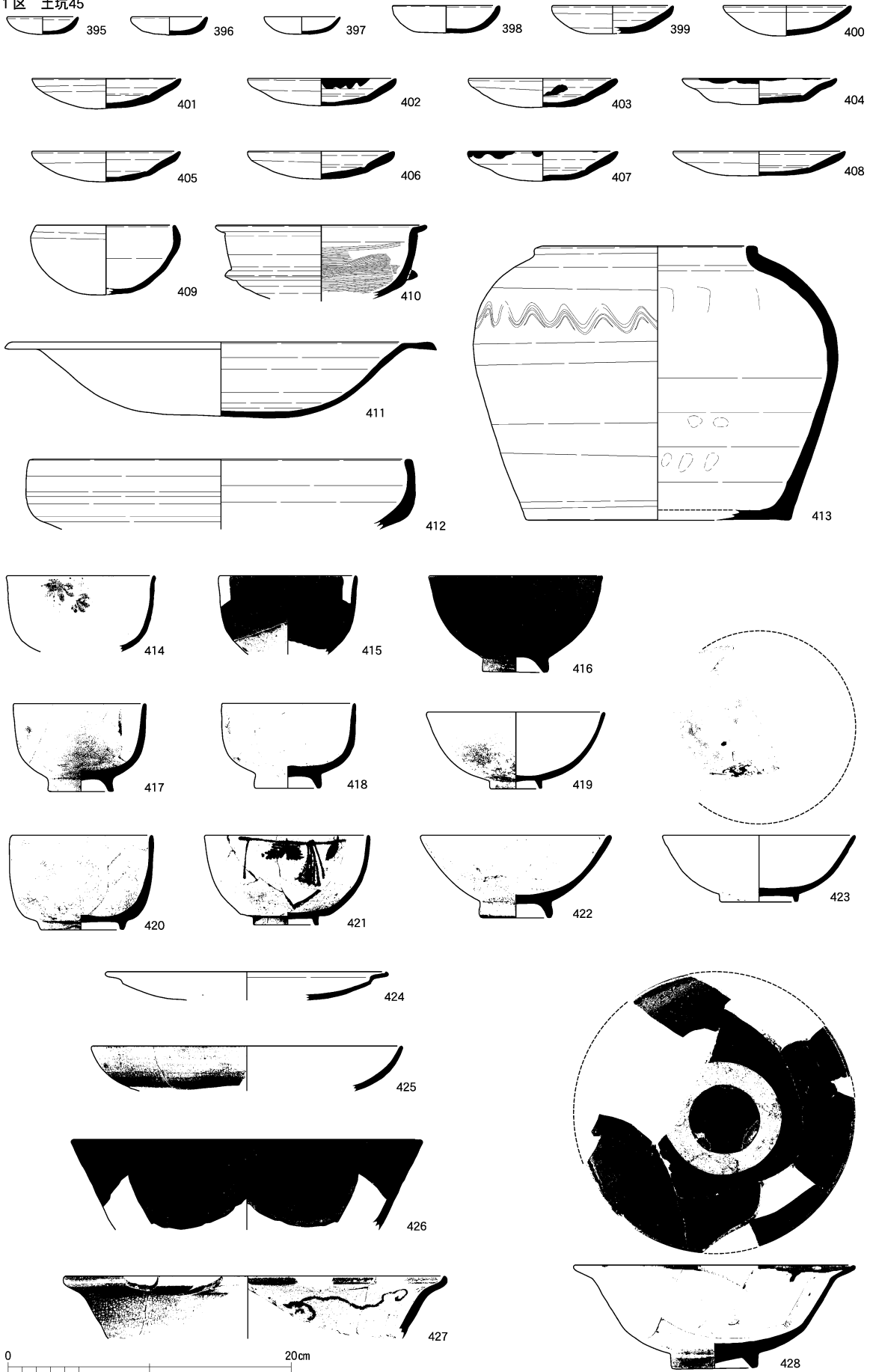

土器実測図9 (1:4)

1区 土坑45

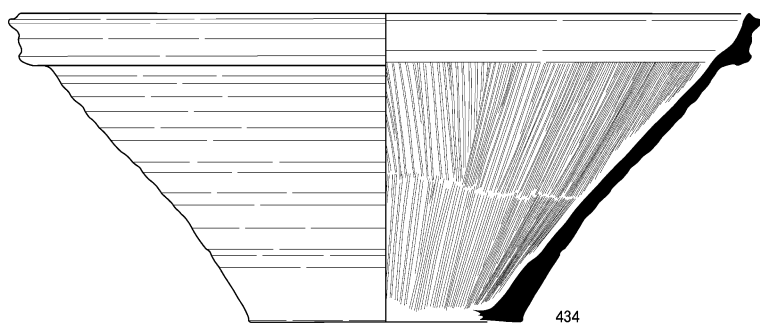
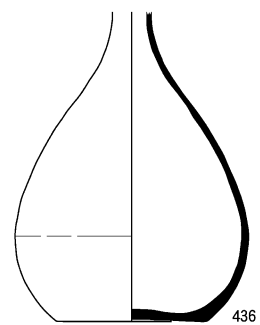
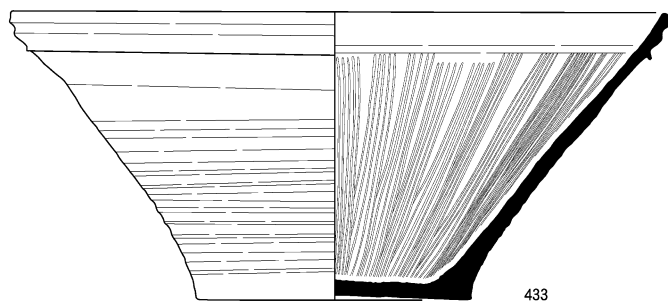
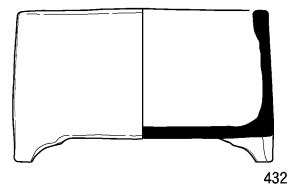
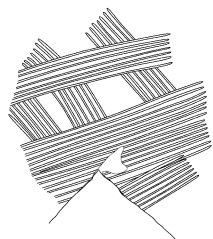
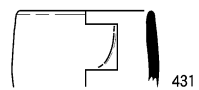
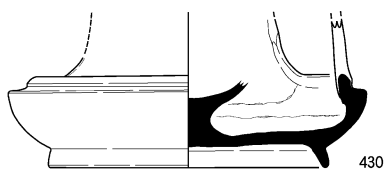
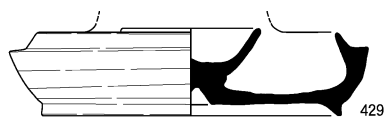

その他の遺構

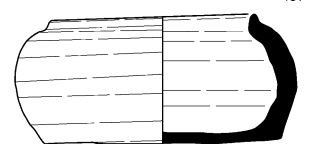
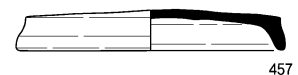
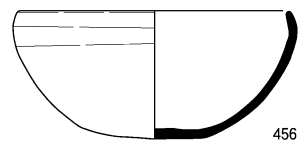
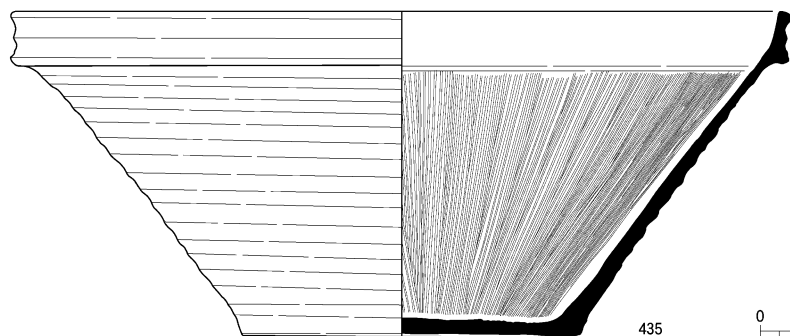
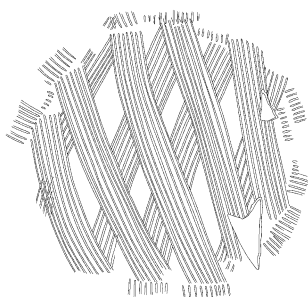
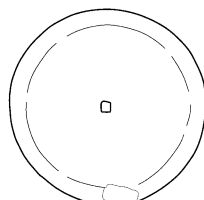

土器実測図 10 (1 : 4)

1区 土坑45



437

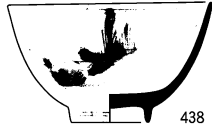

438

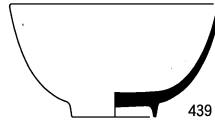

439

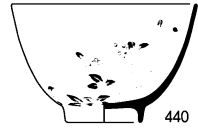

440

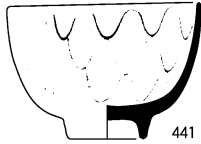

441

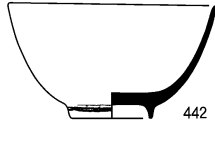

442

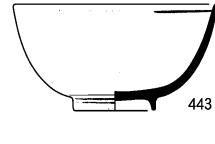

443

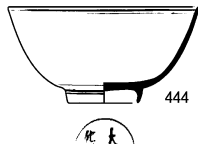

444

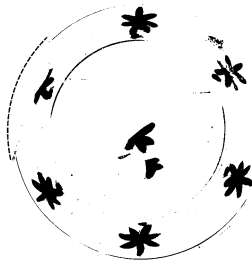

447

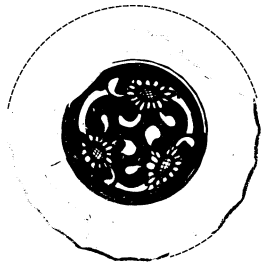

448



445



446

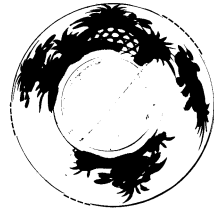

451



449

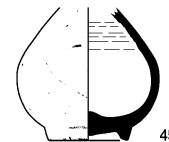
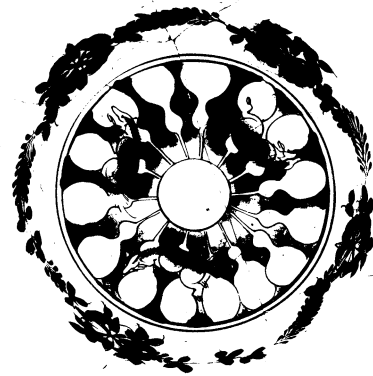

452

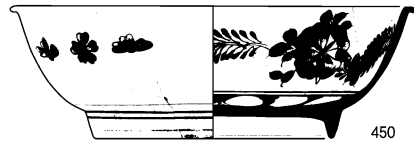

450

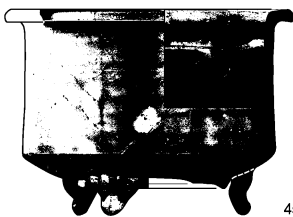

453

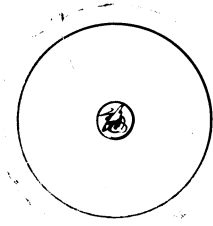
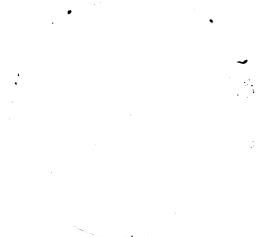

土器実測図 11 (1 : 4)

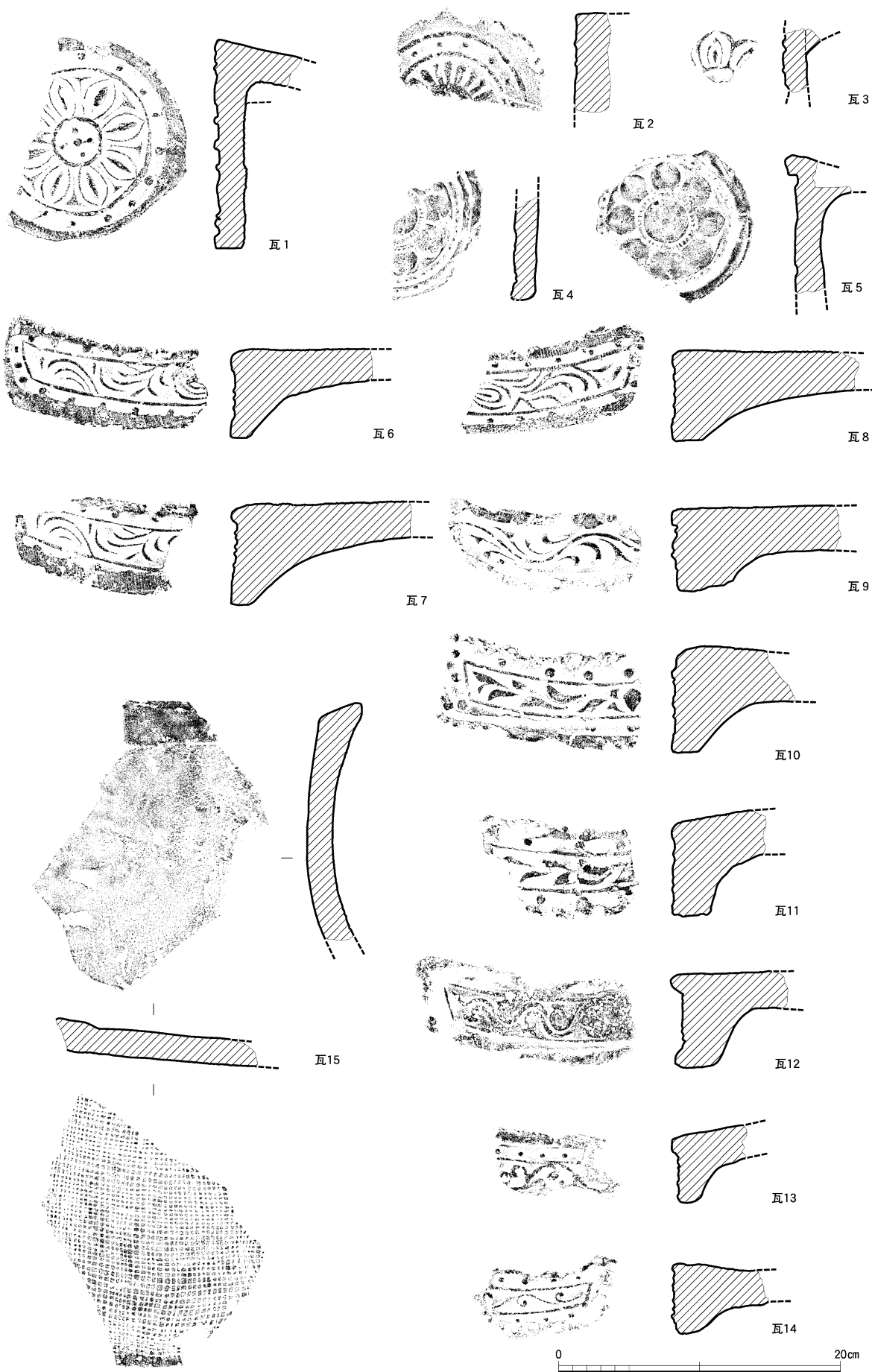

瓦類拓影・実測図1 (1:4)

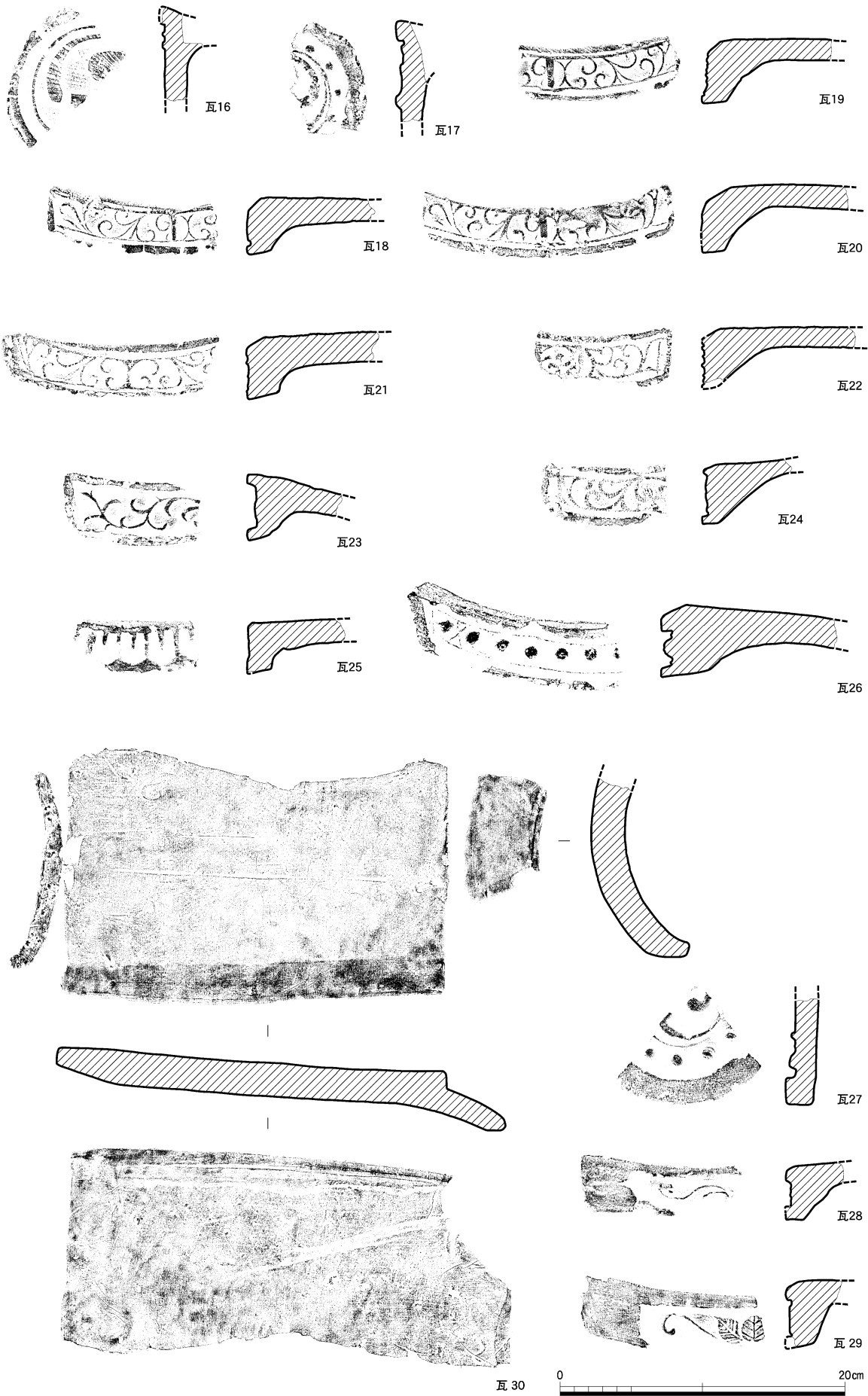

瓦類拓影・実測図2 (1:4)

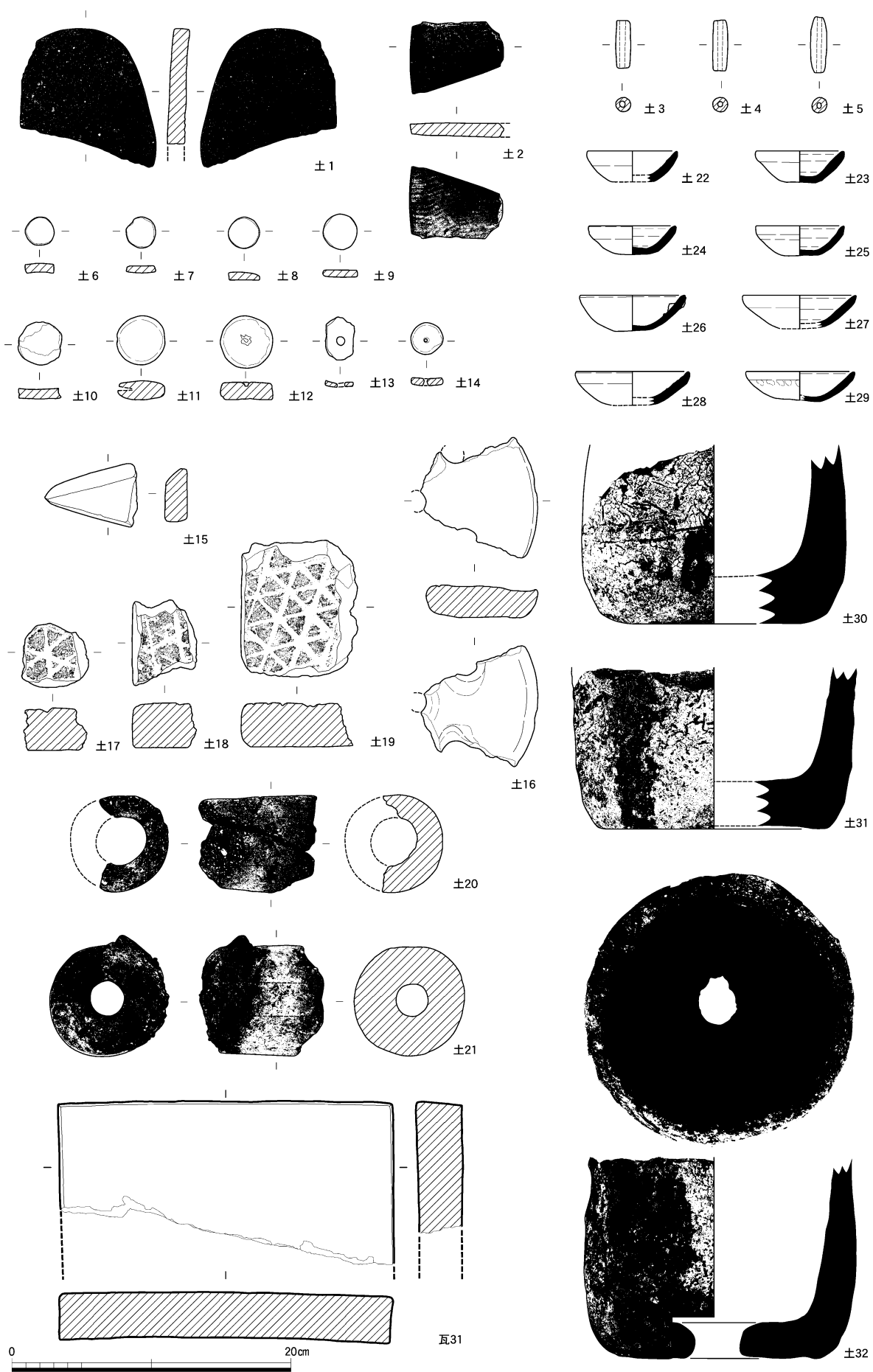

瓦類実測図3、土製品実測図1 (1 : 4)

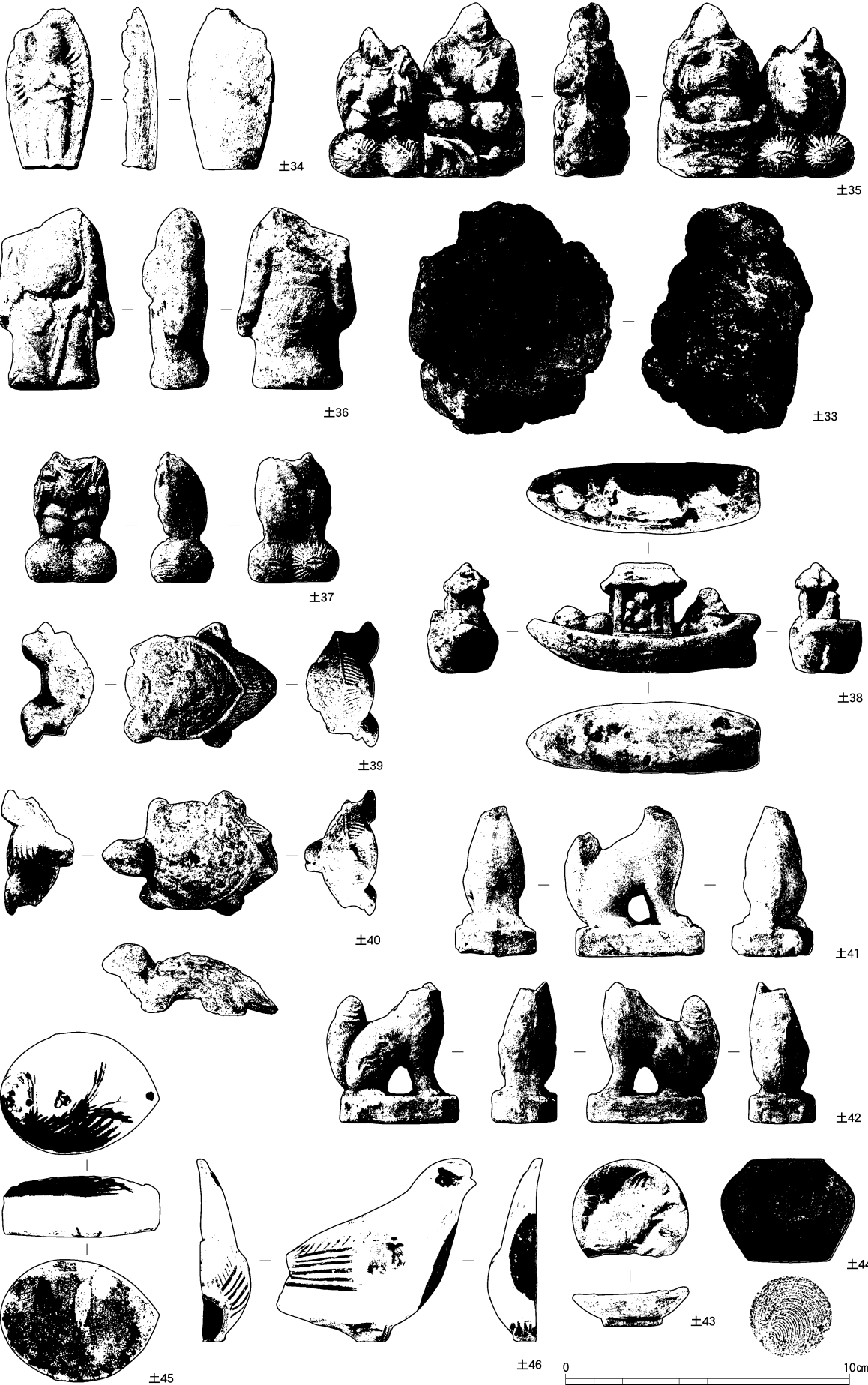

土製品実測図2 (1 : 4)

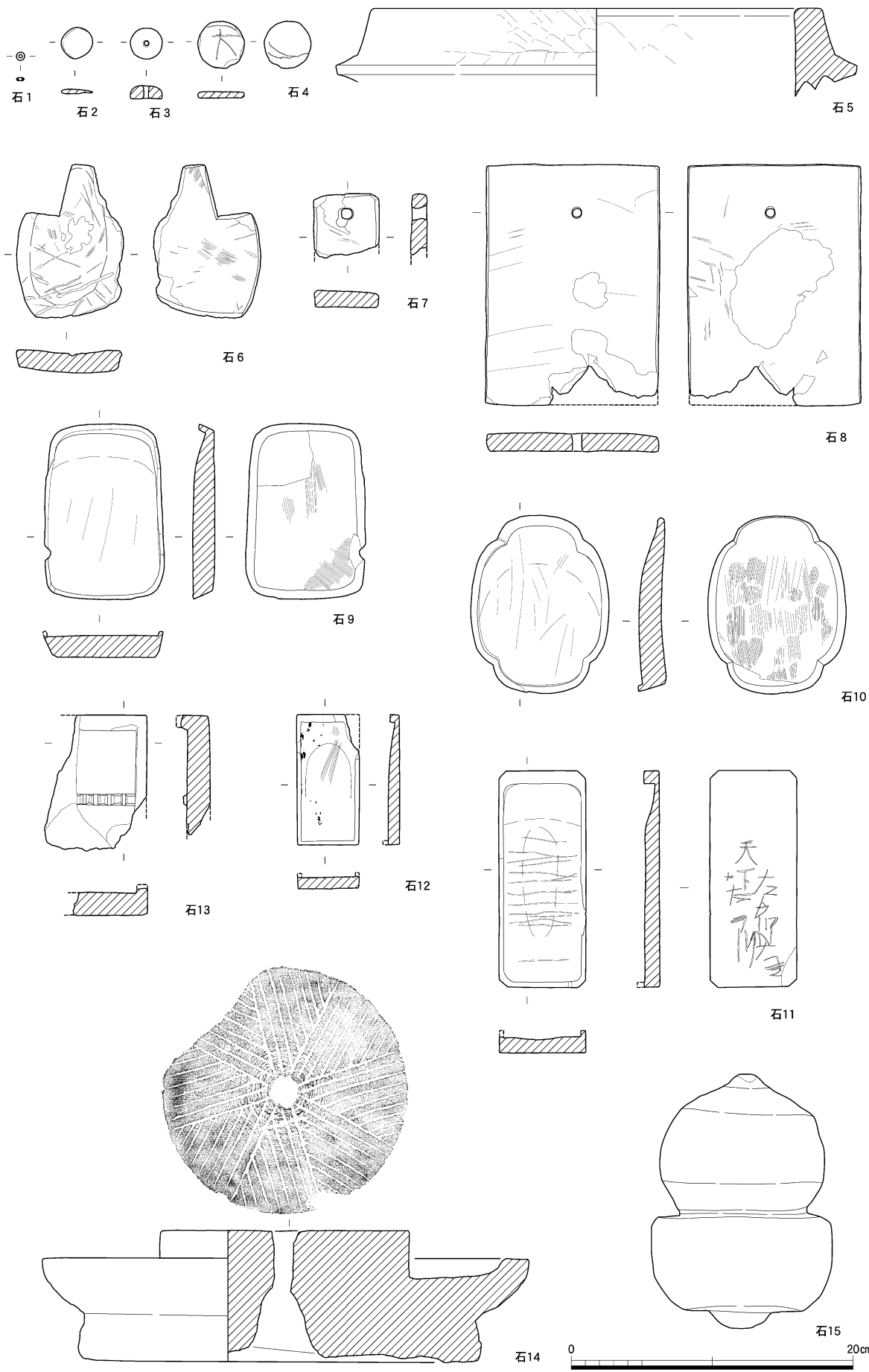

石製品実測図 (1 : 4)

图版 24
遺物

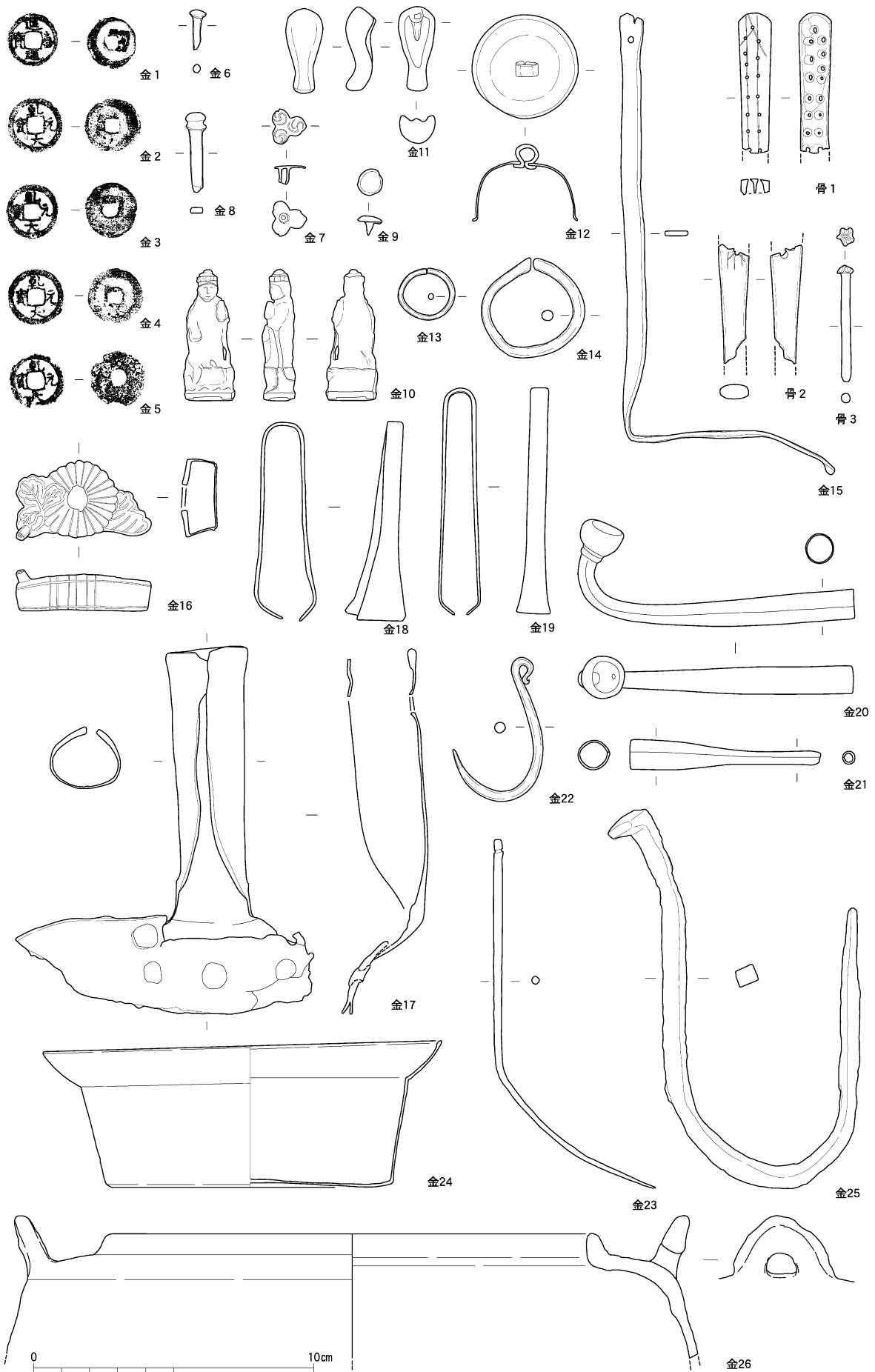

金属製品、骨角製品実測図（1：2）



1 1区南壁断面（北北東から）



2 2区西壁断面（北東から）



1 1区第1面全景（東北東から）



2 1区溝160（北から）



1 1区襲据付穴 177・182 (東北東から)



2 1区竈 218 (南から)



1 1区第2面全景（東北東から）



2 1区土坑 390 土器出土状況（南東から）



1 1区井戸 435・452 (北北西から)



2 1区井戸 304 (北東から)



3 1区井戸 430 (東から)



1 1区地下室410（北から）



2 1区地下室410南端（北から）



1 1区第3面全景（東北東から）



2 1区井戸 583（西から）

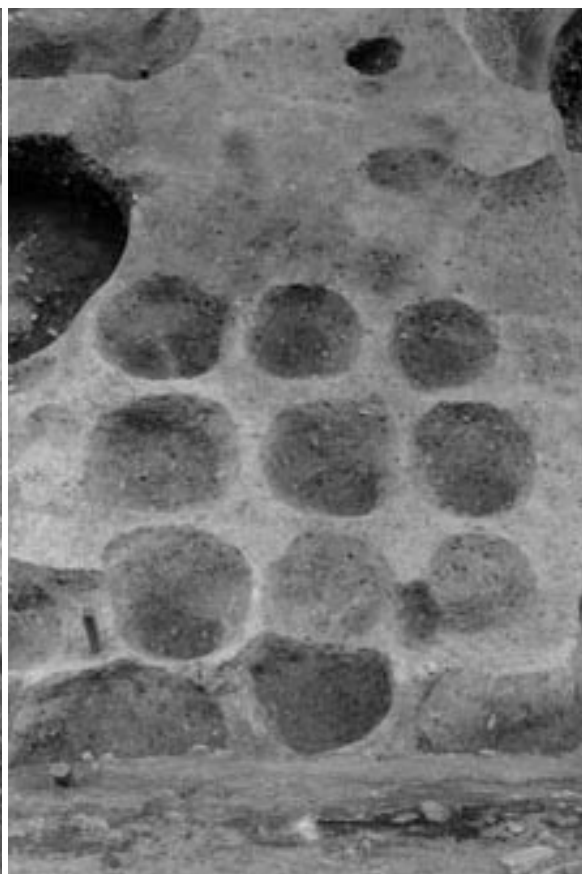

3 1区襷据付穴群（北から）



1 1区流路 632 南壁断面（北北東から）



2 1区流路 632 縄文土器出土状況（西から）



3 1区流路 632B 弥生土器出土状況（西から）



1 2区第1面全景（北から）



2 2区穴蔵1（南から）



1 2区石室 168 (南から)



2 2区石室 169・170 (南東から)



3 2区穴蔵1 土器出土状況 (北北西から)



4 2区土蔵70 土器出土状況 (北西から)



1 2区第2面全景（北から）



2 2区溝 230 断面（南から）



3 2区集石土坑 275（東から）



4 2区井戸 364（西南西から）



5 2区井戸 368（南南東から）



1 2区第3面全景（北から）



2 2区井戸 394（東から）

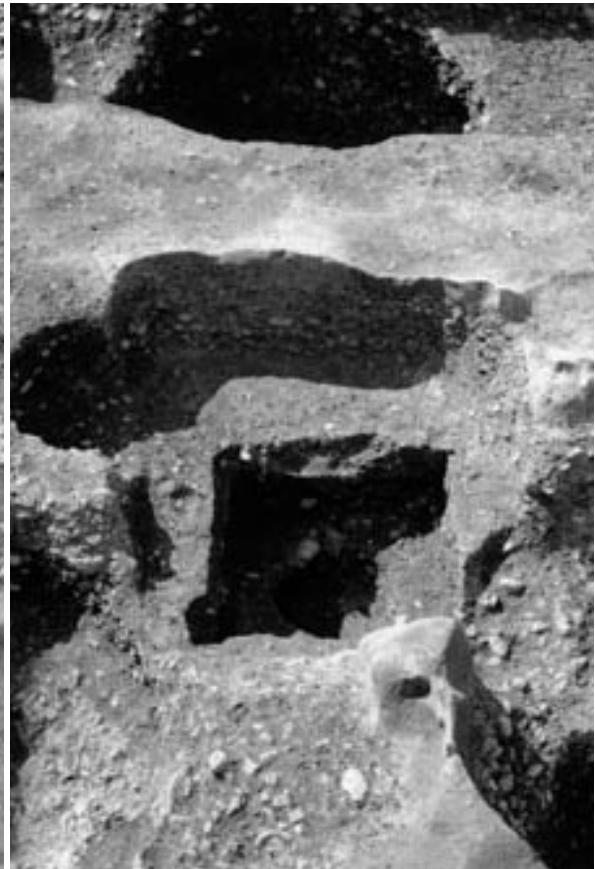

3 2区井戸 395（東から）

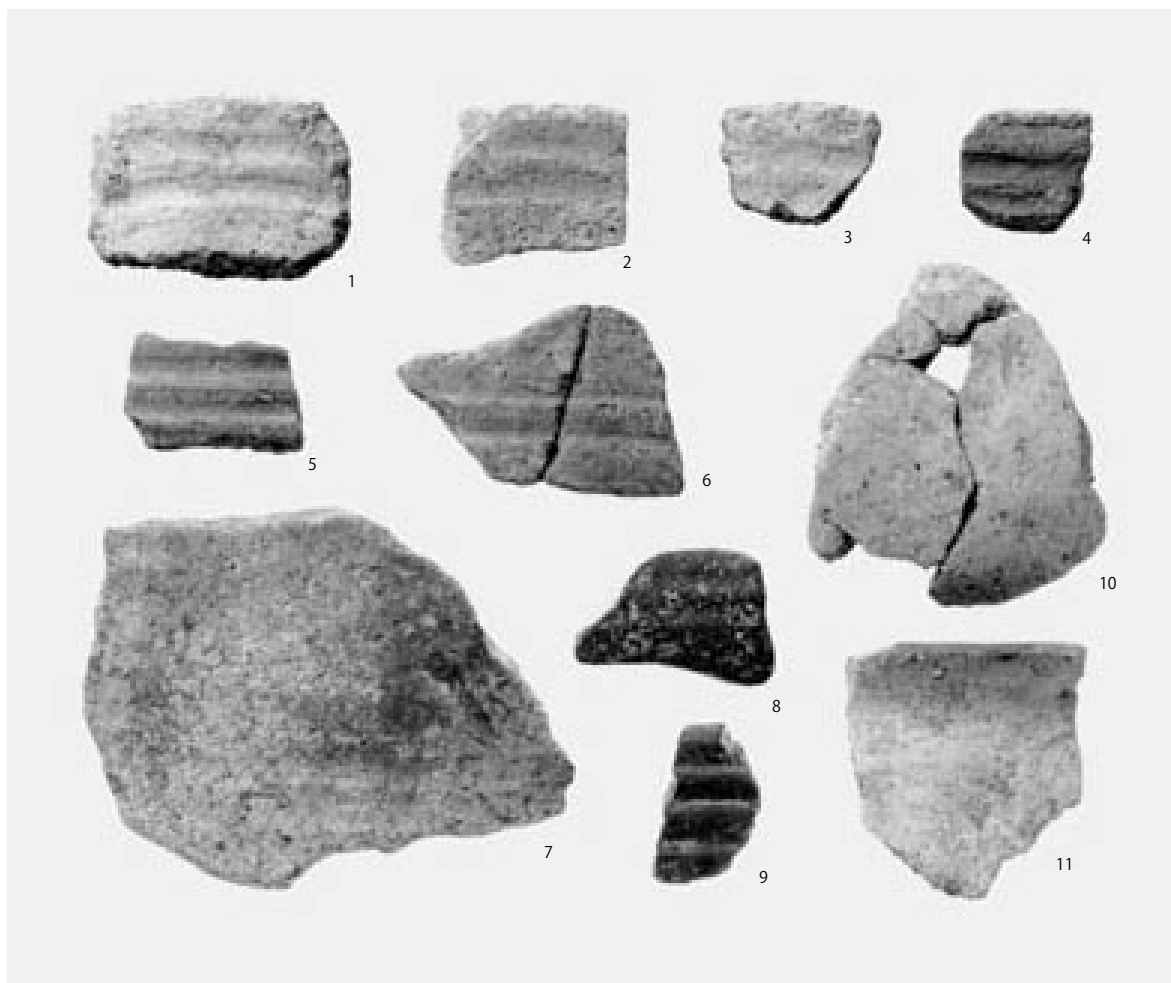

27



21

土器 1



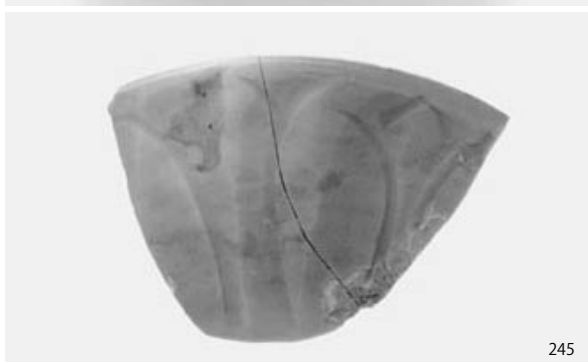

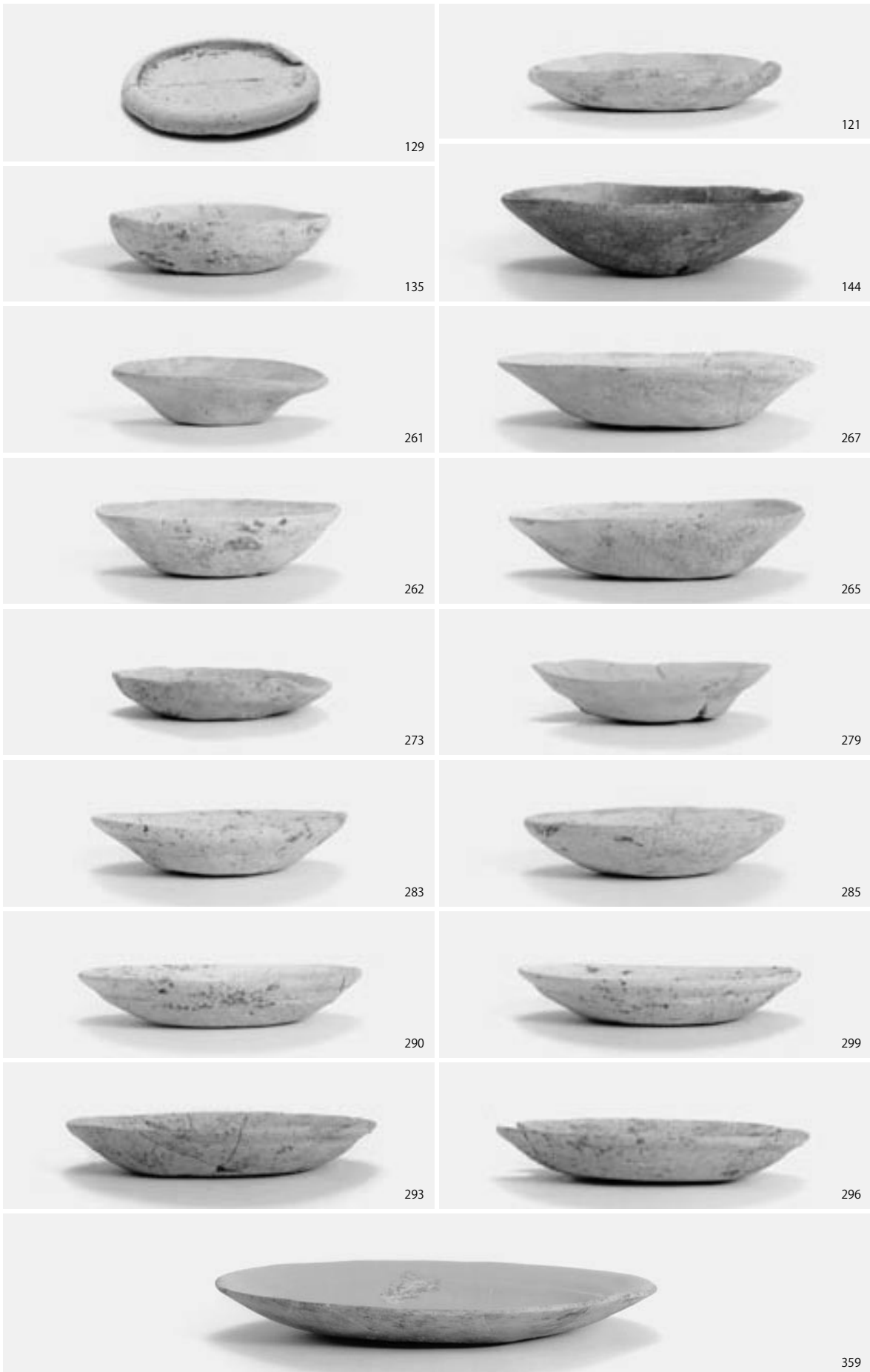

土器 4



瓦 1



瓦 5



瓦 6



瓦 8



瓦 9



瓦 10



瓦 12



瓦 14



瓦 15



瓦 17



瓦 16



瓦 20



瓦 19



瓦 23



瓦 21

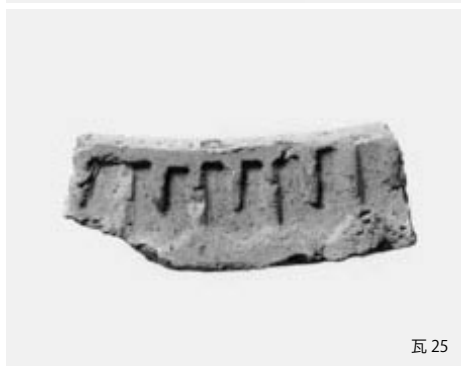

瓦 25



瓦 26



瓦 30



石4



石6

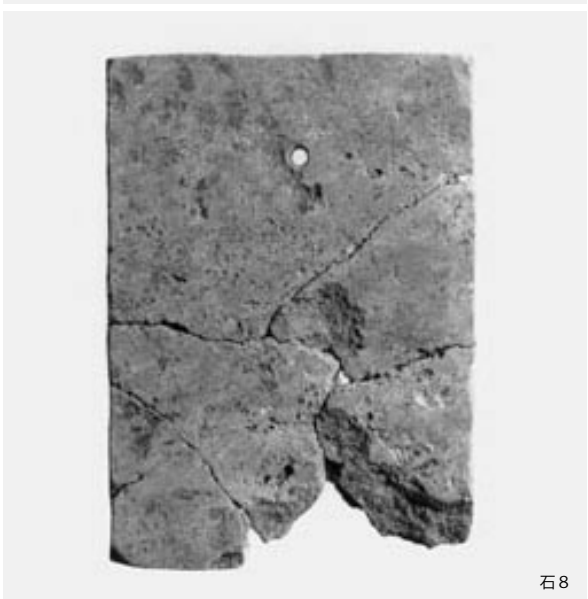

石8



石14

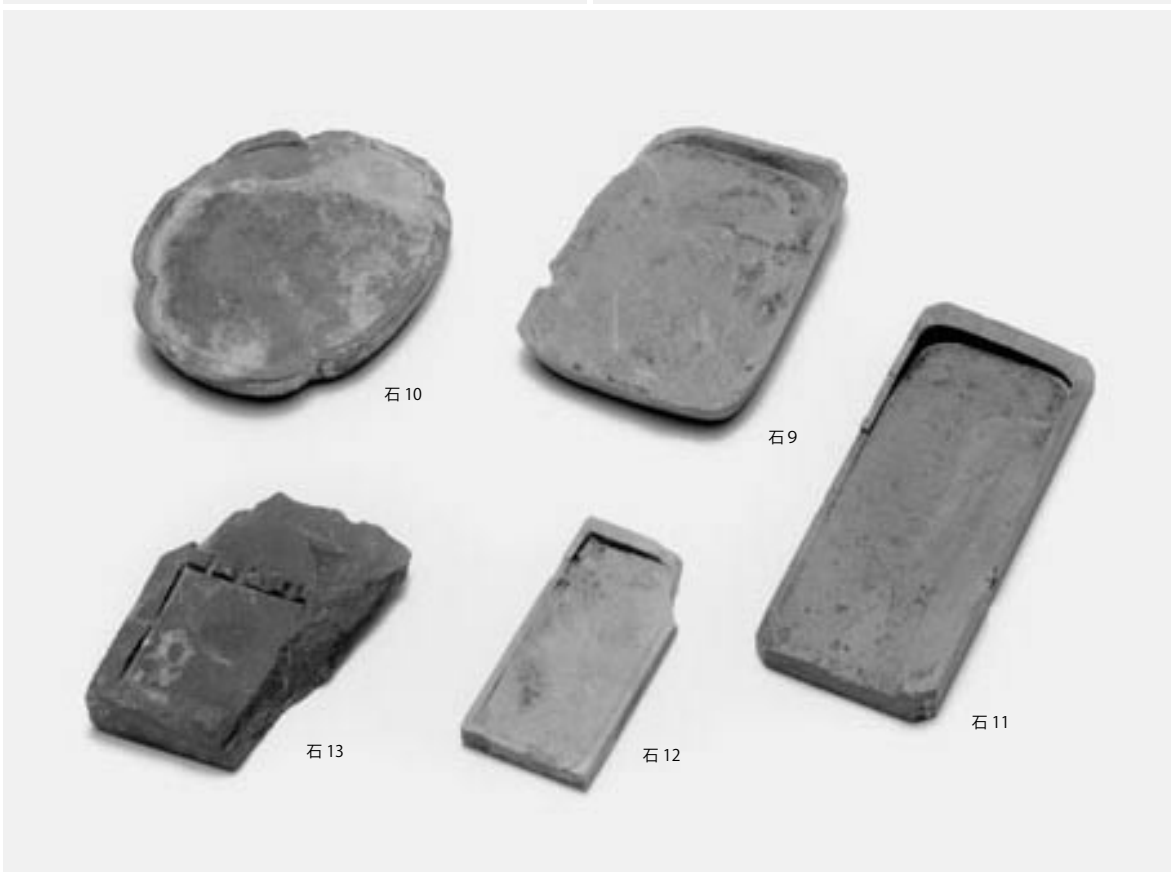

石10

石9

石11

石13

石12

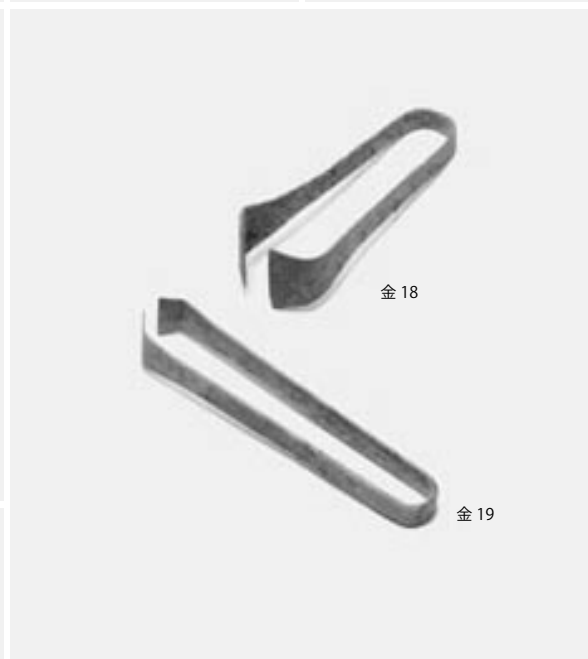
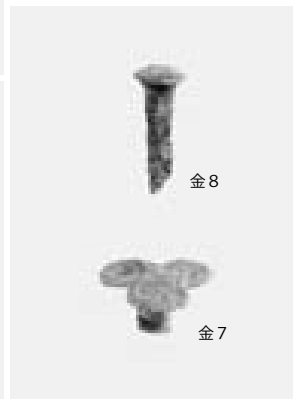
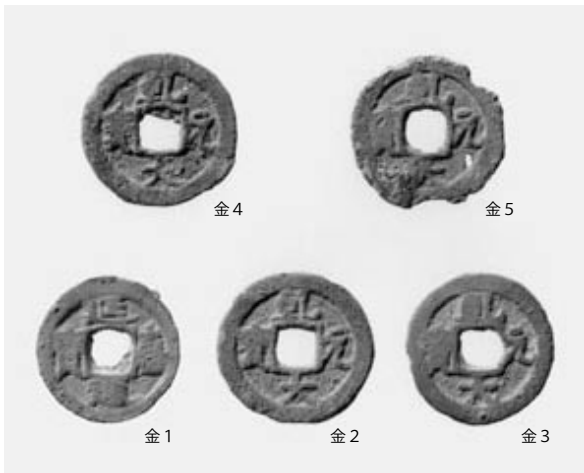



1 ウシの角芯 (2区土坑 58)



2 魚類 (コチ科・マダイ) と鳥類 (カモ科)
(2区土坑 128)

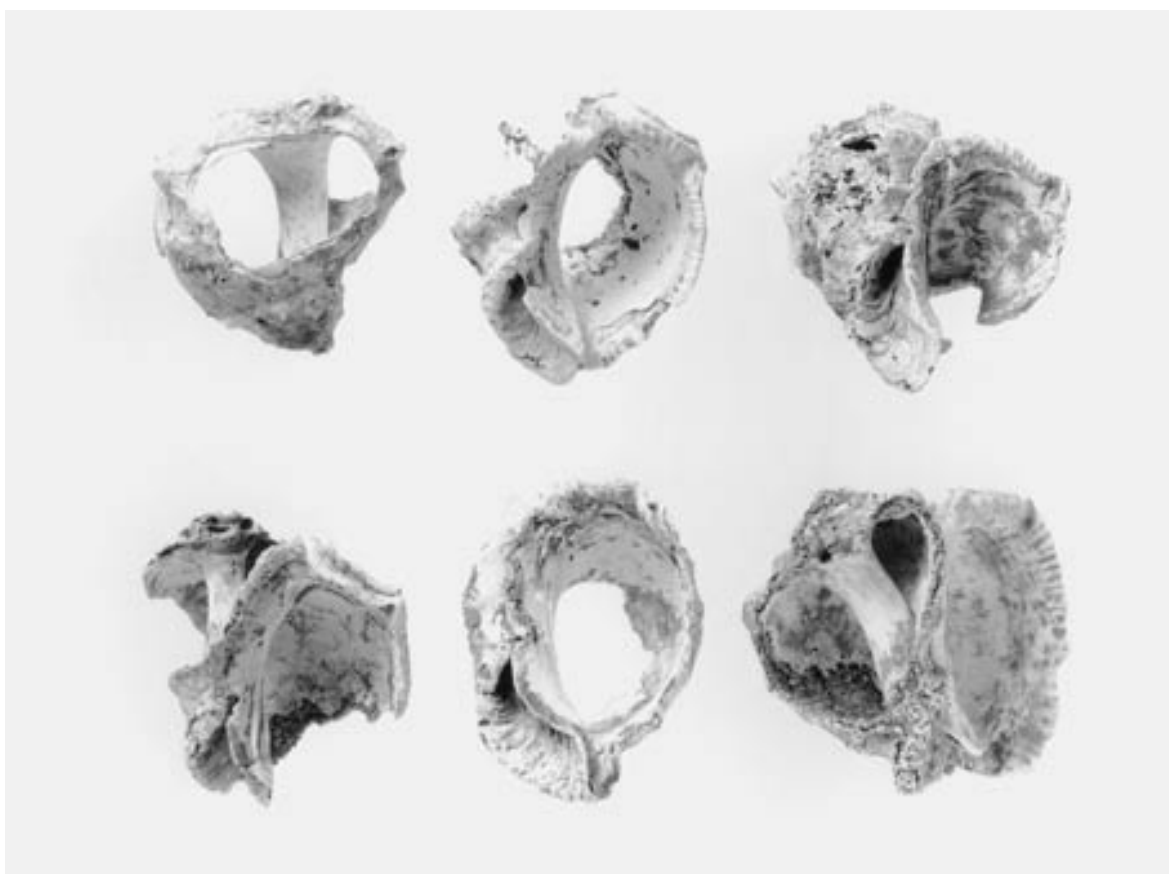

3 アカニシ (1区溝 160)